

Science and Technology Create Perfection

# Installation and Operating Manual

## **SR618C6 SOLAR CONTROLLER**

For Split Pressurized Hot Water System



*Read the instruction carefully please before operation!*

# Contents

<b>1. Safety information</b>	<b>1</b>
1.1 Installation and commissioning	3
1.2 About this manual	3
1.3 Liability waiver	3
1.4 Important remark	4
1.5 Description of symbols	4
1.6 Description of operation button	4
<b>2. Installation</b>	<b>5</b>
2.1 Installing the controller	5
2.2 Power connection	5
2.3 Terminal connection	6
<b>3. Commissioning</b>	<b>8</b>
3.1 Setting time/ week	8
3.2 SCH system selection	8
3.3 Menu structure	10
3.4 Menu description	11
3.5 SCH system description (system 1~system 12)	13
<b>4. Controller functions</b>	<b>25</b>
4.1 Access main menu	25
4.2 Access submenu	25
4.3 Main menu THET Timing heating	26
4.4 DT Temperature difference adjusting function	30
4.5 TEMP Temperature main menu	31
4.5.1 EM Emergency collector temperature (emergency switch-off temperature of collector)	33
4.5.2 CMX Maximum limited collector temperature (collector cooling function)	34
4.5.3 CNN Low temperature protection of collector	35
4.5.4 CFR Frost protection of collector	35
4.5.5 REC Tank re-cooling function	36
4.5.6 SMX1 Maximum temperature of tank 1	37
4.5.7 SMX2 Maximum temperature of tank 2	37
4.5.8 MAX1 Maximum turnoff temperature (for solid fuel boiler, return heating, heat transferring between tanks)	38
4.5.9 MIN1 Minimum turn-on temperature (for solid fuel boiler, return heating, heating transferring between tanks)	39
4.6 FUN Auxiliary function	39
4.6.1 DVWG Anti-Legionella function	40
4.6.2 CIRC Temperature controlled hot water circulation pump	40
4.6.3 nMIN Circuit pump speed adjusting (RPM speed controlling)	41
4.6.3.1 DTS Standard temperature difference (for circuit pump speed adjusting)	42
4.6.3.2 RIS Increased rate (for circuit pump speed adjusting)	42

## **Separated and Pressurized Solar Controller SR618C6 Manual**

---

4.6.4	OHQM thermal energy measuring	43
4.6.4.1	FMAX Flow rate	44
4.6.4.2	MEDT Type of heat transfer liquid	45
4.6.4.3	MED% Concentration of antifreeze	45
4.6.5	PRI0 Priority logic of tank	46
4.6.5.1	TRUN Heating loading- time	47
4.6.5.2	TSTP Heating interval- time	48
4.6.6	INTV Pump interval function	48
4.6.6.1	ISTP Pump interval- time	49
4.6.6.2	IRUN Pump running time	49
4.6.7	BYPR High temperature by-pass function (tank temperature automatically adjusting)	49
4.7	HND Manual mode	50
4.8	PASS Password setting	52
4.9	RSET Recovery factory setting	53
4.10	ON/OFF button	53
4.11	Holiday function	54
4.12	Manual heating	54
4.13	Temperature query function	55
<b>5.</b>	<b>Protection function</b>	<b>56</b>
5.1	Memory protection	56
5.2	Anti-dry heating protection	56
5.3	Screen protection	56
<b>6.</b>	<b>Trouble shooting</b>	<b>56</b>
6.1	Trouble protection	56
6.2	Trouble checking	58
<b>7.</b>	<b>Quality guarantee</b>	<b>59</b>
<b>8.</b>	<b>Technical data</b>	<b>60</b>
<b>9.</b>	<b>Delivery scope</b>	<b>60</b>
<b>10.</b>	<b>Device matchable to this controller</b>	<b>61</b>
<b>11.</b>	<b>Systemsurvey</b>	<b>62</b>

## **1. Safety information**

### **1.1 Installation and commissioning**

- When laying cables, please ensure that no damage occurs to any of the constructional fire safety measures presented in the building.
- The controller can not be installed in rooms where easily inflammable gas mixtures are present or may occur.
- The permissible environmental conditions can not be exceeded at the site of installation.
- Before connecting the device, make sure that the energy supply matches the specifications that controller requires.
- All devices connected to the controller must conform to the technical specifications of the controller.
- All operations on an open regulator are only to be conducted cleared from the power supply. All safety regulations for working on the power supply are valid. Connecting and /or all operations that require opening the regulator (e.g. changing the fuse) are only to be conducted by specialists.

### **1.2 About this manual**

This manual describes the installation, function and operation of a solar thermal controller. When installing the remaining components e.g. the solar collectors, pump assemblies and the storage unit, are sure to observe the appropriate installation instructions provided by each manufacturer.

Installation, electrical connection, commissioning and maintenance of the device may only be performed by trained professional personnel. The professional personnel must be familiar with this manual and follow the instructions contained herein.

### **1.3 Liability waiver**

The manufacturer cannot monitor the compliance with these instructions or the circumstances and methods used for installation, operation, utilization and maintenance of this controller. Improper installation can cause damages to material and persons. This is the reason why we do not take over responsibility and liability for losses, damages or cost that might arise due to improper installation, operation or wrong utilization and maintenance or that occurs in some connection with the aforementioned. Moreover we do not take over liability for patent infringements or infringements – occurring in connection with the use of this controller- on third parties rights. The manufacturer preserves the right to put changes to product, technical date or installation and operation instructions without prior notice. As

soon as it becomes evident that safe operation is no longer possible (e.g. visible damage). Please immediately take the device out of operation. Note: ensure that the device cannot be accidentally placed into operation.

#### **1.4 Important remark**

We have carefully checked the text and pictures of this manual and provided the best of our knowledge and ideas, however inevitable errors maybe exist. Please note that we can not guarantee that this manual is given in the integrity of image and text, they are just some examples, and they apply only to our own system. Incorrect, incomplete and erroneous information and the resulting damage we do not take responsibility.

#### **1.5 Description of symbols**



Safety instruction:

The safety instructions in the manual are marked with a warning triangle. It indicates measures, which can lead to personal injury and safety risks.

Operation steps: small triangle "▶" is used to indicate operation step.

Notes: Contains important information about operation or function.

#### **1.6 Description of operation button**



On/off



Clock



Manual heating



Holiday



Set button



ESC/confirm



Onwards button



Backwards button

## 2. Installation

Controller can only be installed indoors, and is far away from dangerous place and away from the electromagnetic field. Controller should be equipped with an additional plug, which should have minimum 3mm distance between the pole of the plug or effective compliance with the provisions of the installation. For example, switch or fuse, please note wires should be separated, and use the AC.

### 2.1 Installing the controller

Note: the controller can only be installed in an area having an adequate level of protection.

- ▶ Choosing a suitable site
- ▶ Drilling the up fixing hole
- ▶ Screwing on the screw
- ▶ Taking away the cover plate
- ▶ Hanging the bottom plate on the fixing hole ①
- ▶ Marking the position of fixing hole ② & ③
- ▶ Taking away the bottom plate
- ▶ Drilling the hole ② & ③
- ▶ Rehanging the bottom plate on screw ①
- ▶ Fixing bottom plate with ② & ③ screw

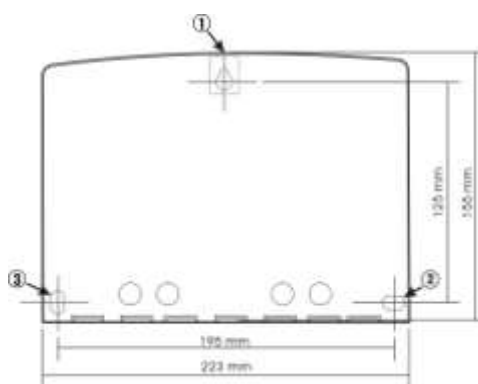

### 2.2 Power connection

Power can only be switched on when the housing of controller is closed, an installer must make sure that the IP protection class of the controller is not damaged during installation.

Depending on the type of installation, the cables may enter the device through the rear hole of the case ④ or the lower side hole of the case ⑤

Cable come from the rear ④: remove the plastic flaps from the rear side of the case using an appropriate tool.

Cable come from the below ⑤: cut the left and right plastic flaps using an appropriate tool (e.g. knife) and break them out of the case.

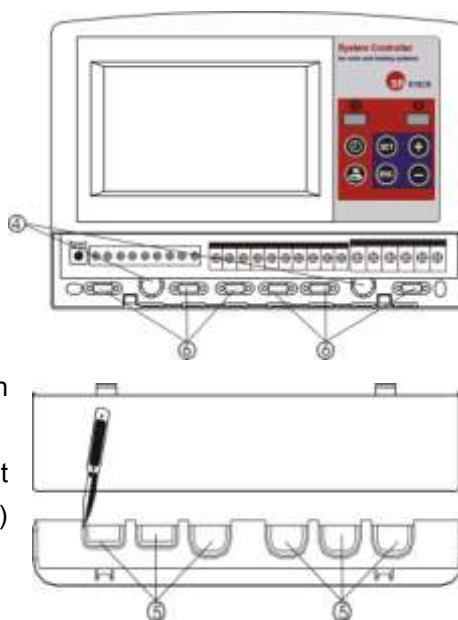

**Notes:** the flexible wire must be fastened to the case using the strain-relief clamps provided

### 2.3 Terminal connection



Before to open the terminal, please be sure to switch-off the power supplier and pay attention to the local electricity supply rules.

- **Terminal layout**

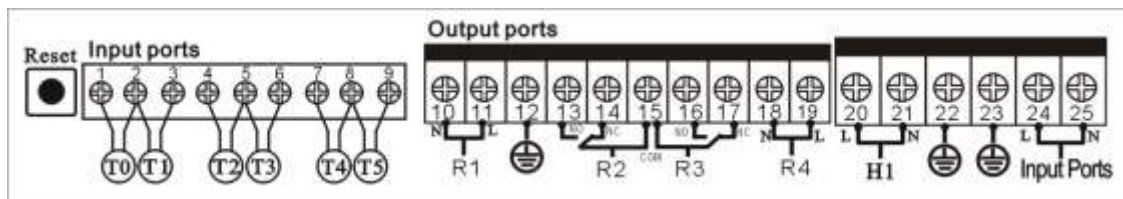

- **Power connection**

Power connection terminals are: (24, 25)

Ground terminals are: (12, 22, and 23)

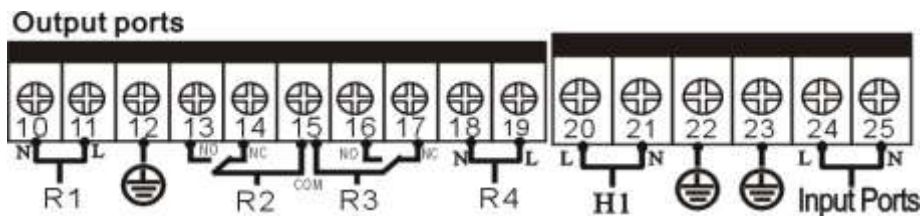

- **Sensor input ports**

Input sensor ports T0, T1: for Pt1000 sensors, used for measuring the temperature of collector

Input sensor ports T2, T3, T4, and T5: for NTC10K, B=3950 sensors, used for measuring the temperature of tank or pipe.

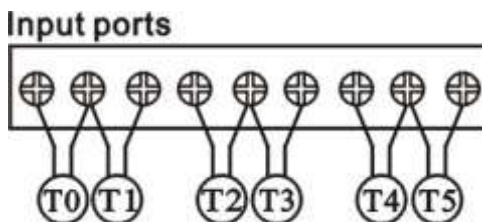

- **Advice regarding the installation of temperature sensors**

Only original factory equipped Pt1000 temperature sensors are approved for use with the collector, it is equipped with 1.5m silicon cable and suitable for all weather conditions, the temperature sensor and cable are temperature resistant up to 280 °C, not necessary to distinguish the positive and negative polarity of the sensor connection.

Only original factory equipped NTC10K,B=3950 temperature sensors are approved for use with tank and pipe, it is equipped with 1.5m PVC cable, and they are temperature resistant up to 105 °C, not necessary to distinguish the positive and negative polarity of the sensor connection.

All sensor cables carry low voltage, and it is necessary to take measures to avoid inductive effects, so sensor cables should not be laid close to 230 volt or 400 volt cables (minimum separation of 100mm)

If external inductive effects are existed, e.g. from heavy current cables, overhead train cables, transformer substations, radio and television devices, amateur radio stations, microwave devices etc, then the cables to the sensors must be adequately shielded.

Sensor cables may be extended to a maximum length of ca. 100 meter, when cable's length is up to 50m, and then 0.75mm<sup>2</sup> cable should be used. When cable's length is up to 100m, and then 1.5mm<sup>2</sup> cables should be used.

● **Output ports**

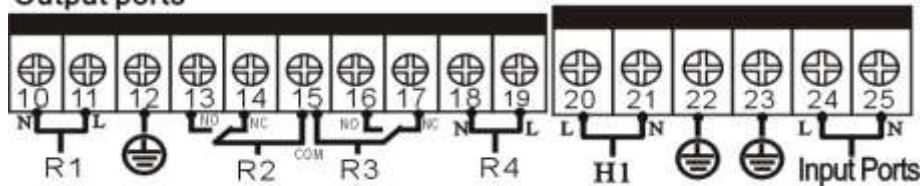

**Output R1:** Semiconductor relay (SCR relay), suitable for RPM control and switch control, max. switching current 1A,

R1 connection terminal (10, 11)

**Output R2:** Electromagnetic relay, max. switching current 3.5A,

R2 connection terminal: for circulation pump (13, 15); for three way electromagnetic valve (13, 15 ports always open, 14,15 ports always close)

**Output R3:** Electromagnetic relay, max. switching current 3.5A,

R3 connection terminal: for circulation pump (15, 16); for three way electromagnetic valve (15, 16 ports always open, 15, 17 ports always close)

**Output R4:** Electromagnetic relay, max. switching current 3.5A,

R4 connection terminal: for circulation pump (18, 19)

**Output H1:** Electromagnetic relay, max. switching current 10A,

H4 connection terminal: for auxiliary heater (20, 21)

**Note:** the connection of the pump and sensors depends on the chosen solar system, every port can only connect one cable, fine core cables should be protected by insulation.











### 3. Commissioning



Connect the sensors, pumps or switching valves to the controller before you connect the power supply!

After switching on power to the controller, firstly it will ask for to set the time, password, select system and set the parameter of system.

#### 3.1 Setting time/week

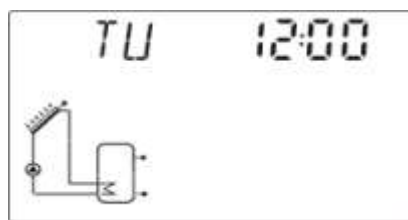

- ▶ Press  button, time displays on the screen, hour selection area "00" blinks on display screen.
- ▶ Press   button to set hour of clock
- ▶ Re-press , minute selection area "00" blinks
- ▶ Press   to set minute of clock.
- ▶ Re-press  again, week selection area "MO" blinks
- ▶ Press   to set week.
- ▶ Press  to exit program, or waiting for 20 seconds, controller exits automatically, the setup parameters are saved automatically.











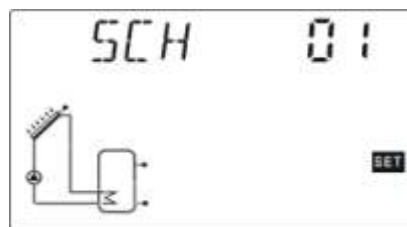





Code	Week day
MO	Monday
TU	Tuesday
WE	Wednesday
TH	Thursday
FR	Friday
SA	Saturday
SU	Sunday

#### 3.2 SCH system selection

Under standby status, access to the main menu to choose SCH system

- ▶ Press  button, "PWD 0000" displays on screen, the left digital blinks, ask for enter password.
- ▶ Press   button to enter the first digital of password.



- ▶ Press  again, second digital blinks,
- ▶ Press   button to enter the second digital of password
- ▶ Press  again, the third digital blinks,
- ▶ Press   button to enter the third digital of password
- ▶ Press  again, the fourth digital blinks,
- ▶ Press   button to enter the fourth digital of password
- ▶ Press  button again, to access the main menu, "SCH 01" displays on screen.
- ▶ Press  to enter system selection program, "01" blinks, the first system of this controller displays on screen
- ▶ Press   button to select desired system (possible for 10 systems)
- ▶ Press  to exit the program, or waiting for 20 seconds to exit automatically, the set up parameters are saved automatically.

### 3.3 Menu structure

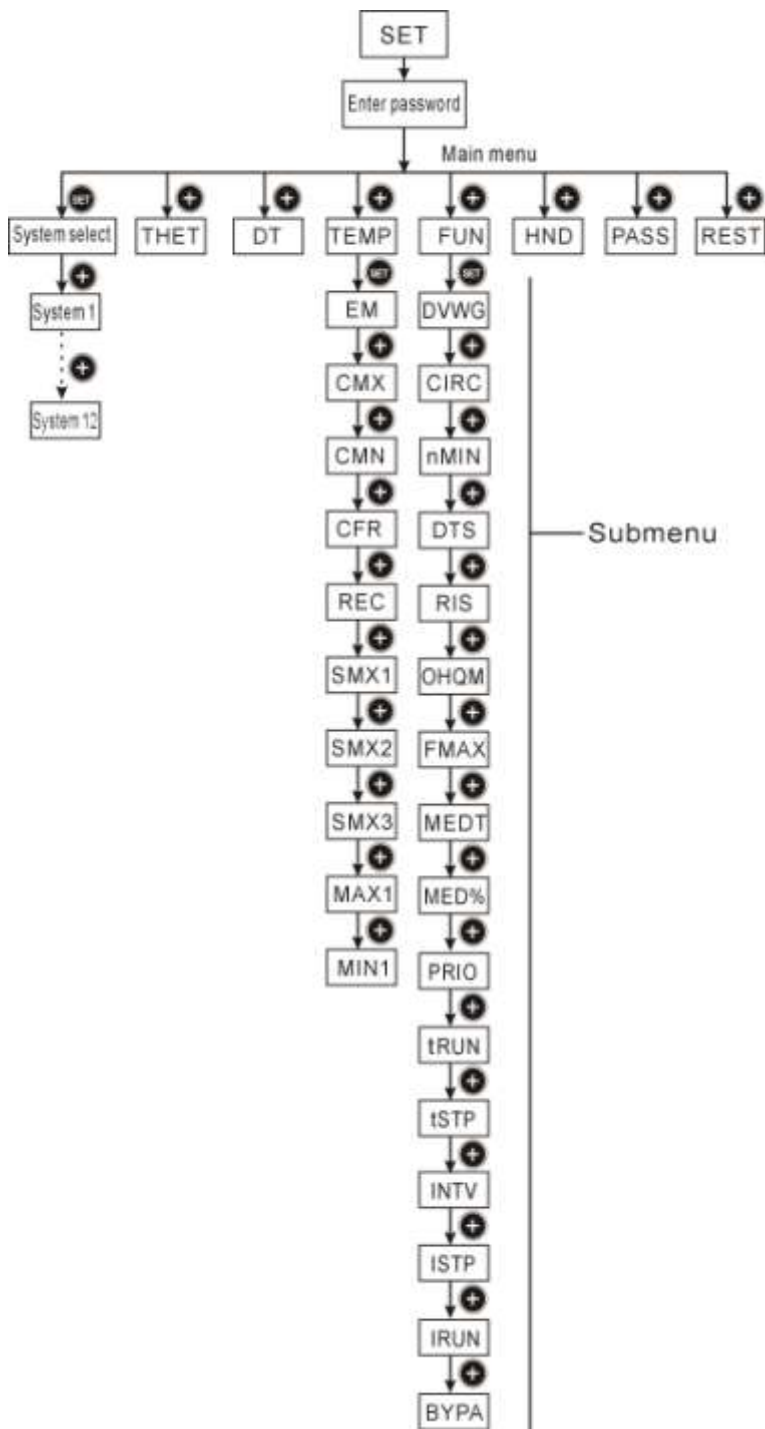

**Submenu:**

Through submenu, customer can set the parameter as desired value, please check it carefully.

### 3.4 Menu description

Serial Nr.	Code (Main menu)	Code (Submenu)	Menu Description
●	SCH		System
●	THET		Timing heating
●	DT		Temperature difference
●	TEMP		Temperature
		EMOF	Collector maximum switch-off temperature
		EMON	Collector maximum switch-on temperature
		CMX	Maximum temperature of collector (Collector cooling function)
		CMN	Low temperature protection of collector
		CFR	Frost protection of collector
		REC	Tank recooling function
		SMX1	Maximum temperature of tank 1
		SMX2	Maximum temperature of tank 2
		MAX1	Maximum turnoff temperature ( for solid fuel boiler, return heating, and heating transfer between tanks)
		MIN1	Minimum turn-on temperature( for solid fuel boiler, return heating, and heating transfer between tanks)
●	FUN		Auxiliary function
		DVWG	Anti legionel function
		CIRC	Temperature controlled hot water circulation pump
		nMIN	Speed controlling of circulation pump (RPM pump controlling )
		DTS	Standard temperature difference (for circulation pump speed adjusting)
		RIS	Increase rate (circulation pump speed adjusting )
		OHQM	Thermal energy measuring
		FMAX	Flow rate
		MEDT	Type of heat transfer liquid
		MED%	Concentration of antifreeze
		PRIO	Priority logic of storage tank
		TRUN	Heating loading time
		TSTP	Heating interval time

**Separated and Pressurized Solar Controller SR618C6 Manual**

---

		INTV	Pump interval function
		ISTP	Pump interval time
		IRUN	Pump running time
		BYPA	By pass ( high temperature)
●	HDN		Manually controlling
●	PASS		Password set
●	REST		Recovery to factory set

### 3.5 SCH System description (System 1 ~ System 12)

**Note:**

T3 is alternative sensor, when no sensor (T3) is installed in the top part of tank, controller will use the signal of sensor T2 automatically to control the auxiliary heating or the circulation pump.

**SYSTEM 1 (SCH 01):**

**1 collector array – 1 storage tank – 1 solar pump - auxiliary heating**

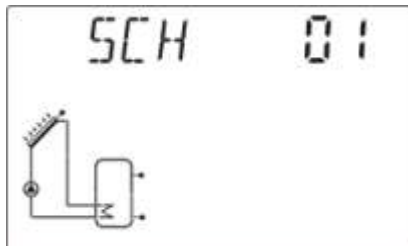

**Description:**

The solar circuit pump (R1) is switched on as soon as the switch-on temperature difference ( $\Delta T_{on}$ ) between the collector array (T1) and the storage tank (T2) is reached. If the temperature difference between the collector array (T1) and storage tank (T2) drops below the switch-off temperature difference ( $\Delta T_{off}$ ), or the temperature of storage tank (T3) reaches to its maximum storage temperature, then the solar circuit pump (R1) is switched off.

**Back-up heating by auxiliary heat resource (detailed see paragraph 4.3):**

Within the preset time section of back-up heating, if the temperature T3 of tank is below the switch-on temperature, then the output ( H1) of back-up heating is triggered, when T3 is heated to the switch-off temperature, output H1 of back-up heating is ceased.

T0: Sensor for measuring the thermal energy (optional sensor)

T1: Temperature sensor for collector array 1

T2: Temperature sensor in the bottom part of tank 1.

T3: Temperature sensor in the top part of tank 1 (optional sensor)

T5: Temperature sensor on hot water circulation pipe (optional sensor)

R1: Solar circuit pump 1

H1: Output for back-up electrical heater

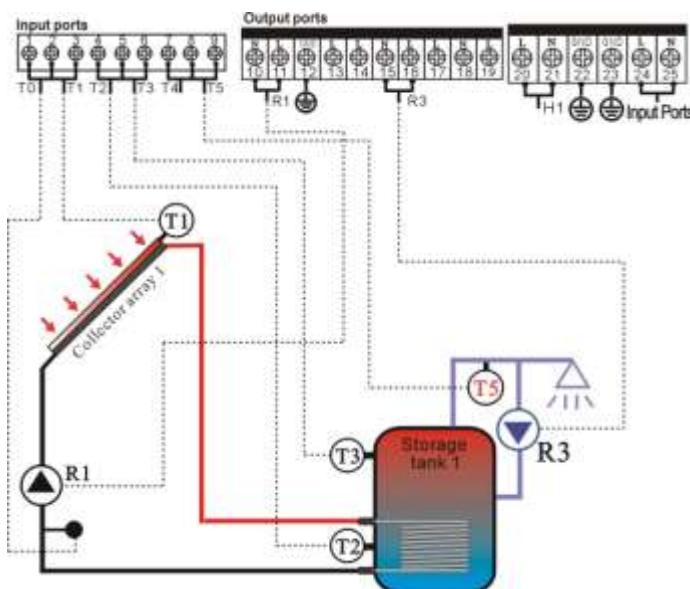

**SYSTEM 2 (SCH 02):**

**1 collector array – 1 storage tank – 1 solar pump  
– electromagnetic valve controlled auxiliary gas boiler**

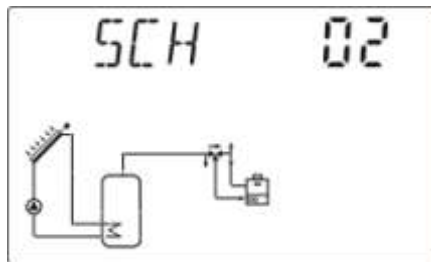

**Description:**

The solar circuit pump (R1) is switched on as soon as the switch-on temperature difference ( $\Delta T_{on}$ ) between the collector array (T1) and the storage tank (T2) is reached. If the temperature difference between the collector array (T1) and storage tank (T2) drops below the switch-off temperature difference ( $\Delta T_{off}$ ), or the temperature of storage tank (T3) reaches to its maximum storage temperature, then the solar circuit pump (R1) is switched off.

**Back-up heating by electromagnetic valve controlled auxiliary boiler (detailed see paragraph 4.3):**

Within the preset time section of back-up heating, in the case that there is requiring of hot water, but the temperature T3 is below the switch-on temperature, then electromagnetic valve (H1) is turned to auxiliary boiler, water flows through gas boiler and is heated for use. When T3 is reached to the switch-off temperature, electromagnetic valve (H1) turns to reversed position, hot water flows direct to the circulation pipe.

T0: Sensor for measuring the thermal energy (optional sensor)

T1: Temperature sensor for collector array 1

T2: Temperature sensor in the bottom part of tank 1.

T3: Temperature sensor in the top part of tank 1(optional sensor)

T5: Temperature sensor on hot water circulation pipe (optional sensor)

R1: Solar circuit pump 1

H1: Electromagnetic valve controlled auxiliary boiler

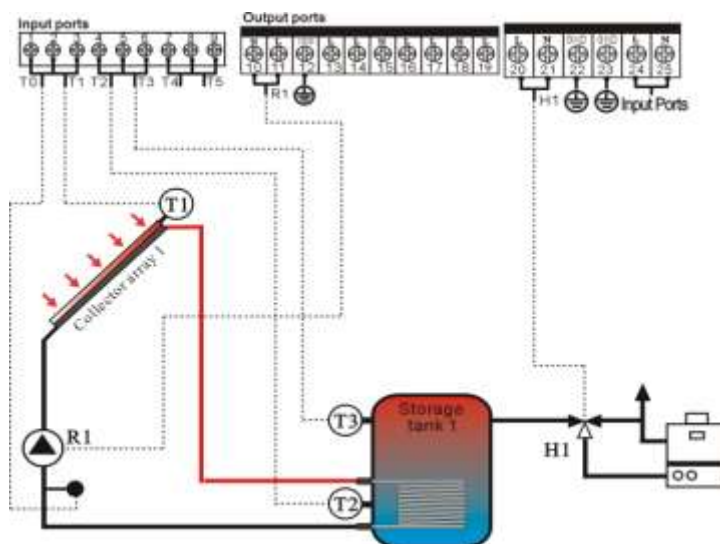

**SYSTEM 3 (SCH 03):**

**1 collector array – 1 storage tank – 1 solar pump  
– 1 circulation pump for auxiliary boiler**

**Description:**

The solar circuit pump (R1) is switched on as soon as the switch-on temperature difference ( $\Delta T_{on}$ ) between the collector array (T1) and the storage tank (T2) is reached. If the temperature difference between the collector array (T1) and storage tank (T2) drops below the switch-off temperature difference ( $\Delta T_{off}$ ), or the temperature of storage tank (T3) reaches to its maximum storage temperature, then the solar circuit pump (R1) is switched off.

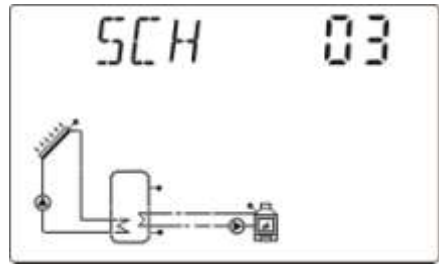

**Back-up heating by auxiliary boiler (detailed see paragraph 4.3):**

Within the preset time section of back-up heating, if the temperature T3 of tank is below the switch-on temperature, then the circulation pump (H1) of back-up heating is triggered, when T3 is heated to the switch-off temperature, circulation pump (H1) of back-up heating is ceased.

T0: sensor for measuring the thermal energy (optional sensor)

T1: Temperature sensor for collector array 1

T2: Temperature sensor in the bottom part of tank 1.

T3: Temperature sensor in the top part of tank (optional sensor)

T5: Temperature sensor on hot water circulation pipe (optional sensor)

R1: Solar circuit pump 1

H1: Output for circulation pump of auxiliary boiler

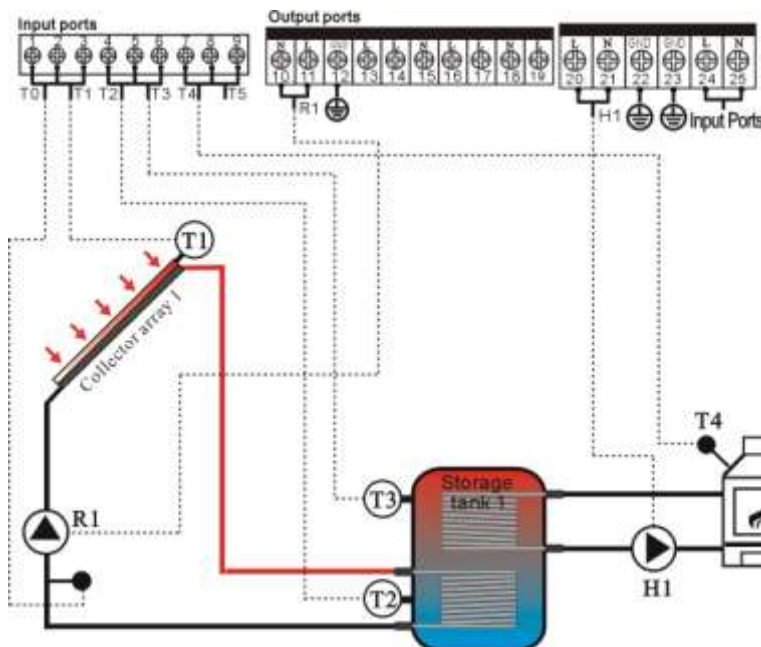

**SYSTEM 4 (SCH 04):**

**1 collector array – 2 storage tanks – 2 solar pumps - auxiliary heating system**

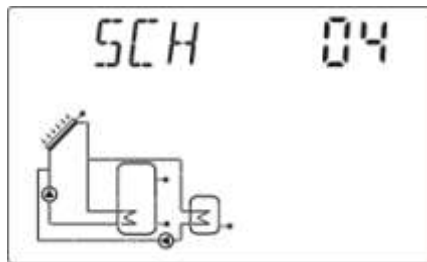

**Description:**

When the temperature difference between collector (T1) and one of two tanks (T2, T4) reaches the switch-on temperature difference ( $\Delta T_{on}$ ), the corresponding solar circuit pump (R1 or R2) are switched on immediately. According to priority logic ( paragraph 4.6.5), two tanks (T2, T4) are heated one by one, When the temperature difference between T1 and one of temperature (T2, T4) drops the switch-off temperature difference ( $\Delta T_{off}$ ), or the temperature of storage tank (T2,T4) reaches to their preset maximum storage temperature, then the solar circuit pumps ( R1, R2) are switched off.

**Back-up heating by auxiliary heat resource (detailed see paragraph 4.3):**

Within the preset time section of back-up heating, if the temperature T3 is below the switch-on temperature, then the output ( H1) of back-up heating is triggered, when T3 is heated to the switch-off temperature, output H1 of back-up heating is ceased.

T1: Temperature sensor for collector array 1

T2: Temperature sensor in the bottom part of tank 1.

T3: Temperature sensor in the top part of tank 1(optional sensor)

T4: Temperature sensor for tank 2

T5: Temperature sensor on hot water circulation pipe (optional sensor)

R1: Solar circuit pump 1

R2: Solar circuit pump 2

H1: Output port for auxiliary heating

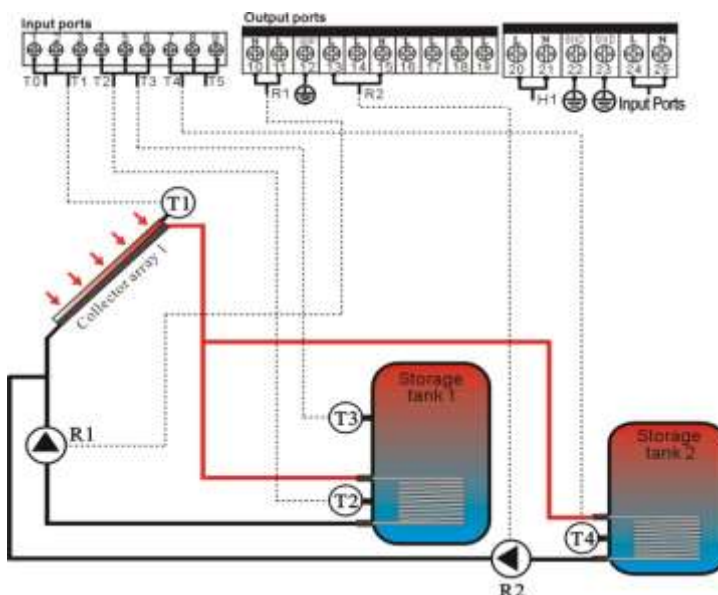

**SYSTEM 5 (SCH 5):**

**1 collector array – 2 storage tanks – 1 pump- 1 electromagnetic valve - auxiliary heating**

**Description:**

When the temperature difference between collector (T1) and one of the two tanks (T2, T4) reaches the switch-on temperature difference ( $\Delta T_{on}$ ), the solar circuit pump (R1) is switched on immediately. And at the same time electromagnetic valve R2 turns to the tank, where asks for heating. According to prior logic ( paragraph 4.6.5), two tanks (T2, T4) are heated one by one. When the temperature difference between T1 and one of tank temperature (T2, T4) drops the switch-off temperature difference ( $\Delta T_{off}$ ), or the temperature of storage tank (T2,T4) reaches their preset maximum storage temperature, then the solar circuit pump ( R1) is switched off.

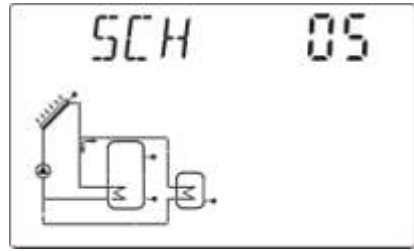

**Back-up heating by auxiliary heat resource (detailed see paragraph 4.3):**

Within the preset time section of back-up heating, if the temperature T3 of tank 1 is below the switch-on temperature, then the output ( H1) of back-up heating is triggered, when T3 is heated to the switch-off temperature, output H1 of back-up heating is ceased.

T1: Temperature sensor for collector array 1

T2: Temperature sensor in the bottom part of tank 1.

T3: Temperature sensor in the top part of tank 1(optional sensor)

T4: Temperature sensor for tank 2

T5: Temperature sensor on hot water circulation pipe (optional sensor)

R1: Solar circuit pump

R2: Electromagnetic valve

H1: Output port for auxiliary heating

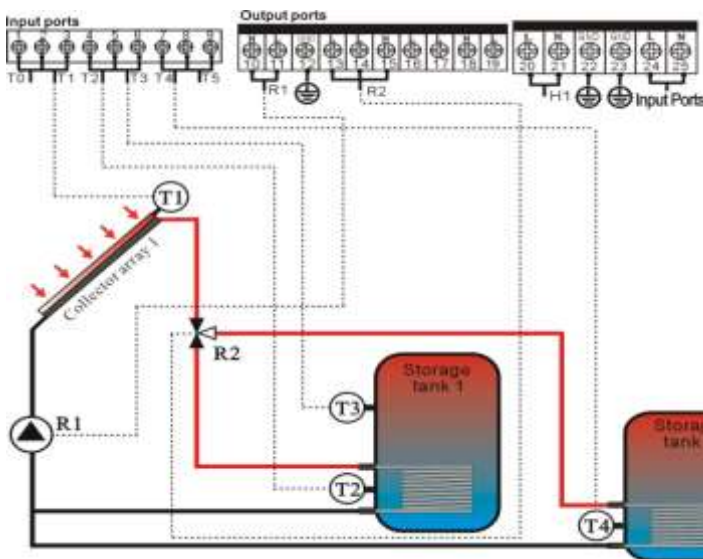

**SYSTEM 6 (SCH 6):**

**2 collector arrays (east/west collector) – 1 storage tank – 2 solar pumps- auxiliary heating system**

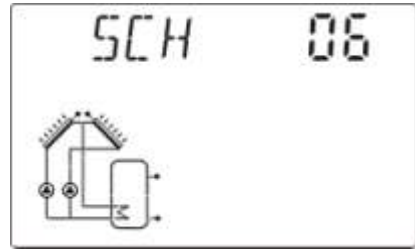

**Description:**

When the temperature difference between one of collector arrays (T1, T0) and tank (T2) reaches the switch-on temperature difference ( $\Delta T_{on}$ ), the corresponding solar circuit pump (R1 or R2) is switched on immediately, if the switch-on temperature difference for both collector arrays is reached, then two pumps R1 and R2 are triggered simultaneously. The ceasing of two pumps are independently, which temperature difference drops below the switch-off temperature, the corresponding pump is stopped, when tank temperature T3 reaches its maximum temperature, two pumps( R1, R2) are ceased.

**Back-up heating by auxiliary heat resource (detailed see paragraph 4.3):**

Within the preset time section of back-up heating, if the temperature T3 of tank 1 is below the switch-on temperature, then the output ( H1) of back-up heating is triggered, when T3 is heated to the switch-off temperature, output H1 of back-up heating is ceased.

T0: Temperature sensor for collector array 2

T1: Temperature sensor for collector array 1

T2: Temperature sensor in the bottom part of tank 1.

T3: Temperature sensor in the top part of tank 1(optional sensor)

T5: Temperature sensor on hot water circulation pipe (optional sensor)

R1: Solar circuit pump 1

R2: Solar circuit pump 2

H1: Output port for auxiliary heating

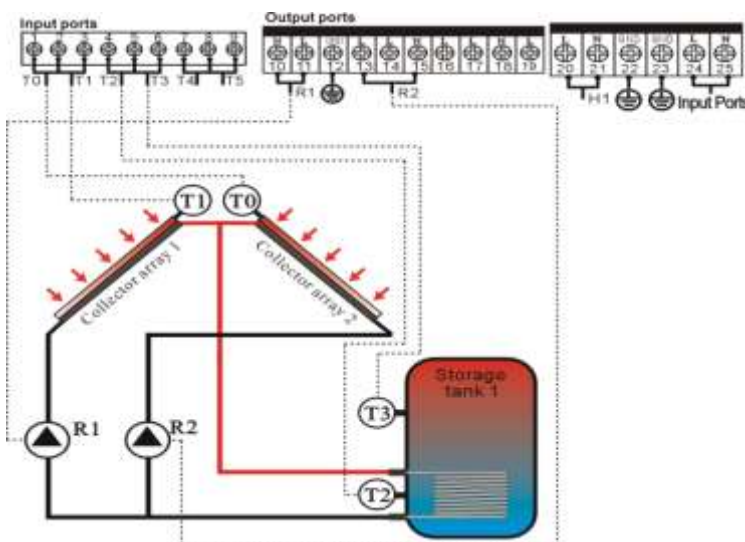

**SYSTEM 7 (SCH 7):**

**2 collector arrays (east/west collector) – 1 storage tank – 1 solar pump- 1 electromagnetic valve - auxiliary heating system**

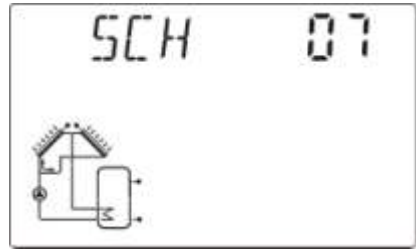

**Description:**

When the temperature difference between one of collector arrays (T1, T0) and tank (T2) reaches the switch-on temperature difference ( $\Delta T_{on}$ ), the solar circuit pump (R1) is switched on immediately, and at the same time, electromagnetic valve is turned to the collector, where its temperature is higher. When the temperature difference between tank temperature T2 and any collector array (T0, T1) drops to the switch-off temperature or when tank temperature T3 reaches its maximum temperature, circulation pump (R1) is ceased.

**Back-up heating by auxiliary heat resource (detailed see paragraph 4.3):**

Within the preset time section of back-up heating, if the temperature T3 of tank is below the switch-on temperature, then the output ( H1) of back-up heating is triggered, when T3 is heated to the switch-off temperature, output H1 of back-up heating is ceased.

T0: Temperature sensor for collector array 2

T1: Temperature sensor for collector array 1

T2: Temperature sensor in the bottom part of tank 1.

T3: Temperature sensor in the top part of tank 1(optional sensor)

T5: Temperature sensor on hot water circulation pipe (optional sensor)

R1: Solar circuit pump 1

R2: Electromagnetic valve

H1: Output port for auxiliary heating

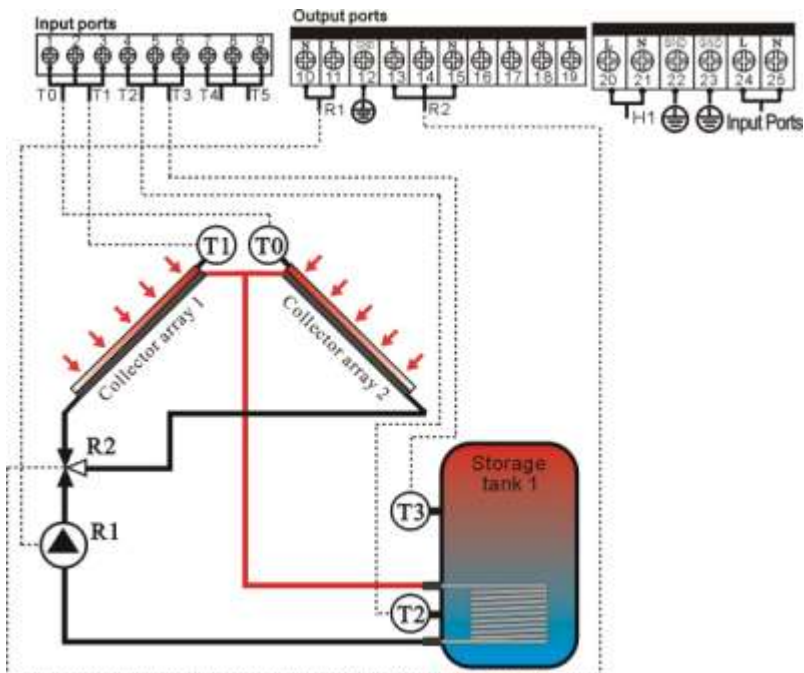

**SYSTEM 8 (SCH 8):**

**Electromagnetic valve controlled 2 collector arrays (east/west collector) – 2 storage tanks – 2 solar pumps- 1 electromagnetic valve – auxiliary heating system**

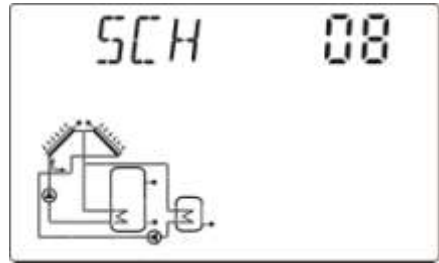

**Description:**

If the temperature difference between one of two tanks ( T2, T4) and collector array 1(T1) or collector array 2 (T2) rises up to the switch-on temperature difference ( $\Delta T_{on}$ ), then electromagnetic valve R2 is turned to the collector, where temperature is higher, correspondingly, the relevant solar circuit pump (R1 or R3) is triggered. Electromagnetic valve is always turned to the collector array, where temperature is higher. According to priority logic ( 4.6.5) tank ( T2, T4) is heated one by one, pump are ceased until the temperature difference between any or both collector arrays ( T1,T0) and relevant tank T2 or T4 drops below the switch-off temperature or when tank temperature T2 or T4 reaches to its maximum temperature.

**Back-up heating by auxiliary heat resource (detailed see paragraph 4.3):**

Within the preset time section of back-up heating, if the temperature T3 of tank is below the switch-on temperature, then the output ( H1) of back-up heating is triggered, when T3 is heated to the switch-off temperature, output H1 of back-up heating is ceased.

T0: Temperature sensor for collector array 2

T1: Temperature sensor for collector array 1

T2: Temperature sensor in the bottom part of tank 1.

T3: Temperature sensor in the top part of tank 1(optional sensor)

T4: Temperature sensor in the bottom part of tank 2

T5: Temperature sensor on hot water circulation pipe (optional sensor)

R1: Solar circuit pump 1

R2: Electromagnetic valve

R3: Solar circuit pump 2

H1: Output port for auxiliary heating

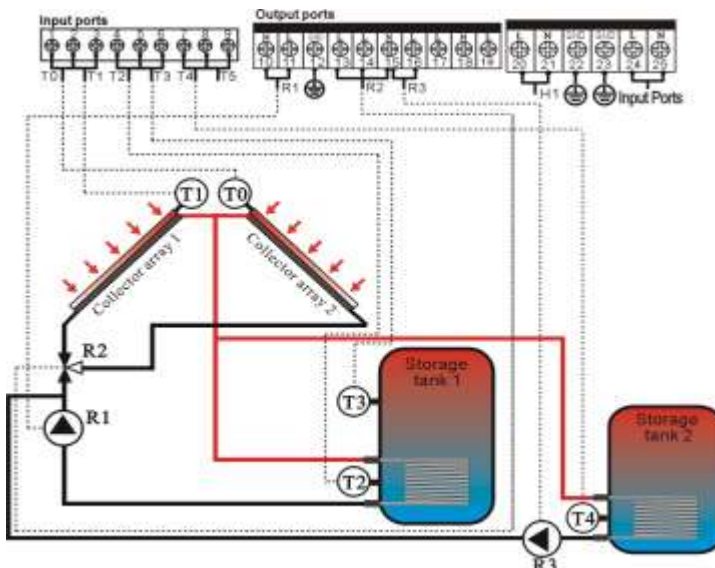

**SYSTEM 9 (SCH 9):**

**Electromagnetic valve controlled 2 collector arrays (east/west collector) – 2 storage tanks – 1 solar pump- 2 electromagnetic valve – auxiliary heating system**

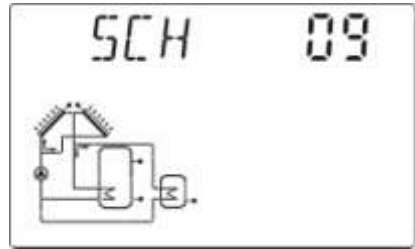

**Description:**

If the temperature difference between one of two tanks (T2, T4) and collector array 1(T1) or collector array 2 (T2) rises up to the switch-on temperature difference ( $\Delta T_{on}$ ), then the solar circuit pump (R1) is triggered, simultaneously, the electromagnetic valve R2 is turned to the corresponding collector array, the electromagnetic valve R3 is turned to corresponding tank, Electromagnetic valve R2 is always turned to the collector array, where temperature is higher. According to priority logic (4.6.5), R3 changes its port to heat tank (T2, T4) one by one. Circulation pump R1 is ceased until the temperature difference between any or both collector arrays (T1, T0) and relevant tank T2 or T4 drops below the switch-off temperature or when tank temperature (T2 or T4) reaches its maximum temperature.

**Back-up heating by auxiliary heat resource (detailed see paragraph 4.3):**

Within the preset time section of back-up heating, if the temperature T3 of tank is below the switch-on temperature, then the output ( H1) of back-up heating is triggered, when T3 is heated to the switch-off temperature, output H1 of back-up heating is ceased.

T0: Temperature sensor for collector array 2

T1: Temperature sensor for collector array 1

T2: Temperature sensor in the bottom part of tank 1.

T3: Temperature sensor in the top part of tank 1(optional)

T4: Temperature sensor in the bottom part of tank 2

T5: Temperature sensor on hot water circulation pipe (optional sensor)

R1: Solar circuit pump 1

R2: Electromagnetic valve 1

R3: Electromagnetic valve 2

H1: Output port for auxiliary heating

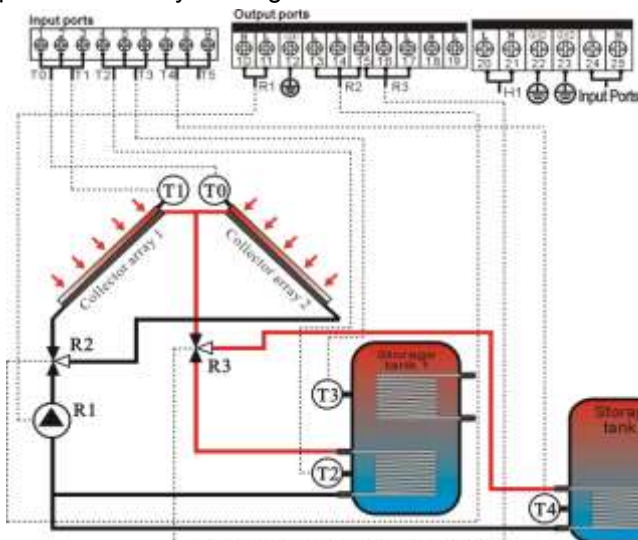

**SYSTEM 10(SCH10):**

**1 collector array – 1 tank with heat exchanger- swimming pool –2 solar pumps - 1 electromagnetic valve- auxiliary heating system**

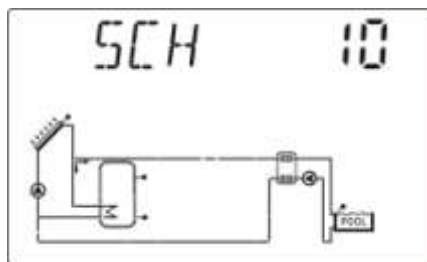

**Description:**

When the temperature difference between collector array (T1) and tank (T2) or swimming pool (T4) reaches the switch-on temperature difference ( $\Delta T_{on}$ ), then the circulation pump (R1 or R3) is triggered. According to priority logic (4.6.5), electromagnetic valve R2 is turned to tank or swimming pool. Tank and swimming pool are heated one by one. When the temperature difference between collector array T1 and tank T2 or swimming pool T4 drops below the switch-off temperature difference ( $\Delta T_{off}$ ), or when tank and swimming pool reaches its maximum temperature, then the solar circuit pump ( R1, R3 ) are switched off.

**Back-up heating by auxiliary heat resource (detailed see paragraph 4.3):**

Within the preset time section of back-up heating, if the temperature T3 of tank is below the switch-on temperature, then the output ( H1) of back-up heating is triggered, when T3 is heated to the switch-off temperature, output H1 of back-up heating is ceased.

T1: Temperature sensor for collector array 1

T2: Temperature sensor in the bottom part of tank

T3: Temperature sensor in the top part of tank (optional sensor)

T4: Swimming pool sensor

R1: Solar circuit pump 1

R2: Electromagnetic valve

R3: Circulation pumps for swimming pool.

H1: Output port for auxiliary heating

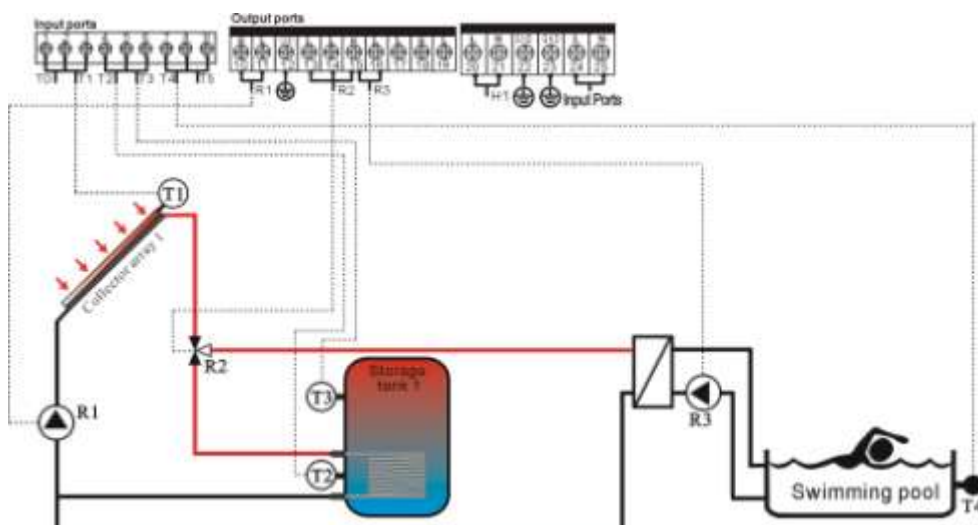

**SYSTEM11(SCH 11):**

**1 collector array – 1 tanks – 1 circuit pumps – 1 three ways electromagnetic valves - back up heating**

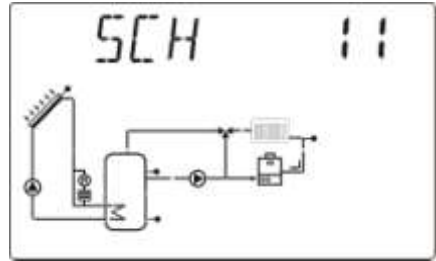

**Description:**

If the temperature difference between collector ( T1 ) and tank (T2) rises up to the switch-on TD, solar circuit pump R1 is triggered. When the temperature difference between collector T1 and tank ( T2 ) drops below the switch-off TD, or tank ( T2 ) temperature rises up to its maximum temperature, solar circuit pump(R1) is ceased.

**Temperature enhancing of return of floor heating: (detailed operation see 4.5.9)**

If temperature difference  $\Delta T_2$  between tank(T3) and heating return(T5) rises up to the switch-on TD, circuit pump(or electromagnetic valve)R3 is triggered, floor heating return is heated by tank; when temperature difference  $\Delta T_2$  between tank(T3) and heating return(T5) drops below the switch-off TD, or tank temperature(T3) is lower than the preset minimum temperature” MIN1”, or temperature of heating return(T5) rises up to the preset maximum temperature “Max1”, circuit pump(or electromagnetic valve) R3 is ceased.

**Back-up boiler heating (see 4.3)**

Within a preset time section of back-up heating, if temperature of tank ( T3 ) drops below the switch-on temperature of heating, then electromagnetic valve H1 turns to back-up boiler and circulation pump H1 is triggered. When temperature of tank (T3) rises up to the switch-off temperature of heating, then electromagnetic valve H1 turns to other side, pump H1 is ceased.

T1: temperature on collector

T2: temperature on low part of tank

T3: temperature on up part of tank ( optional )

T5: temperature on HE

R1: solar circuit pump

R3: three ways electromagnetic valve(or for pump)

R4: by-pass electromagnetic valve

H1: Three ways electromagnetic valve (or for pump)

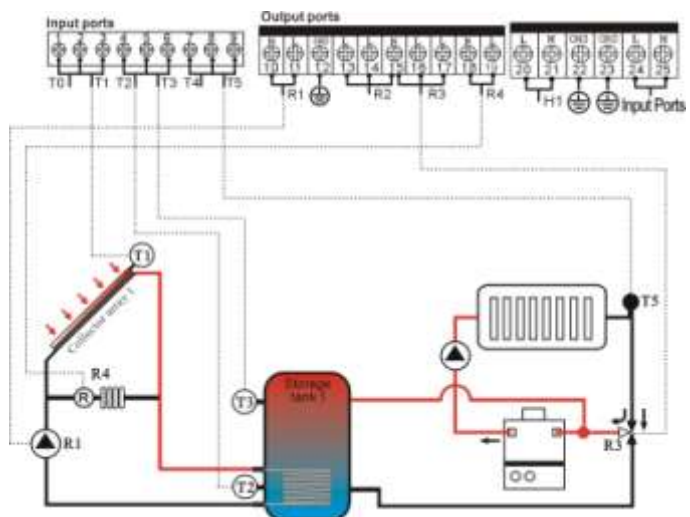

**SYSTEM 12(SCH 12):**

**1 collector array – 2 tanks – 2 circuit pumps – 2 three ways electromagnetic valves - back up heating**

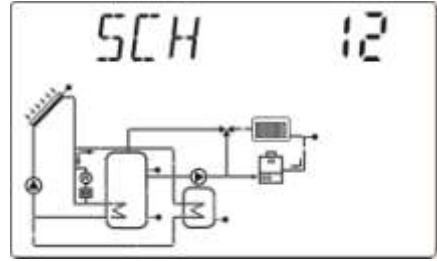

**Description:**

If the temperature difference between collector ( T1 ) and one of two tanks (T2 or T4) rises up to the switch-on TD, solar circuit pump R1 is triggered, and simultaneous electromagnetic valve ( R2) turns to the tank to be heated. Two tanks ( T2, T4 ) are heated one by one. Tank2 is prior to be heated, according to tank priority trigger principle (see item 4.6.5). when the temperature difference between collector T1 and any of two tanks ( T2,T4 ) drops below the switch-off TD, or tank ( T2, T4) temperature rises up to its maximum temperature, solar circuit pump(R1) is ceased.

**Temperature enhancing of return of floor heating: (detailed operation see 4.5.9)**

If temperature difference  $\Delta T_2$  between tank1 T3 and heating return T5 rises up to the switch-on TD, circuit pump R3 is triggered, floor heating return is heated by tank; when temperature difference  $\Delta T_2$  between tank1 T3 and heating return T5 drops below the switch-off TD, or tank1 temperature T3 is lower than the preset minimum temperature” MIN1”, or temperature of heating return T5 rises up to the preset maximum temperature “Max1”, pump(electromagnetic valve) R3 is ceased.

**Back-up boiler heating (see 4.3)**

Within a preset time section of back-up heating, if temperature of tank 2 ( T4) drops below the switch-on temperature of heating, then electromagnetic valve H1 turns to back-up boiler and circulation pump H1 is triggered. When temperature of tank 2 ( T4) rises up to the switch-off temperature of heating, then electromagnetic valve H1 turns to other side, pump H1 is ceased.



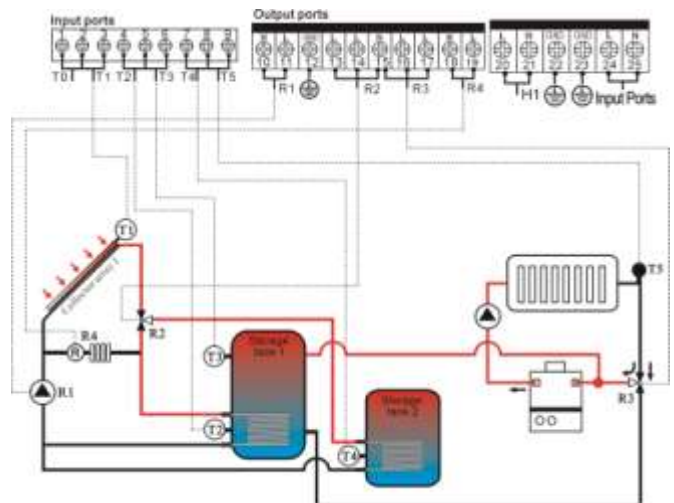













- T1: temperature on collector 1
- T2: temperature on low part of tank 1
- T3: temperature on up part of tank 1  
( optional )
- T4: temperature on tank 2
- T5: temperature on HE
- R1: solar circuit pump
- R2: three ways electromagnetic valve
- R3: three ways electromagnetic valve(circuit pump)
- R4: by-pass electromagnetic valve
- H1: Three ways electromagnetic valve and pump



## 4. Controller functions

### 4.1 Access main menu

Under standby status, doing like following access main menu

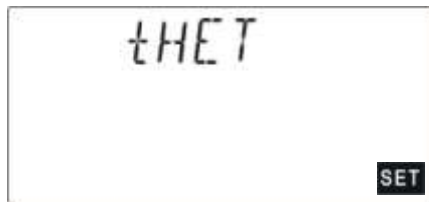
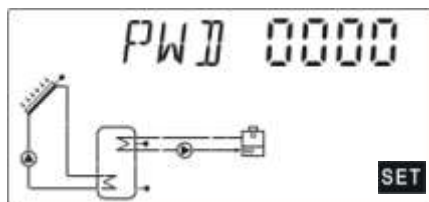

- ▶ Press  button, "PWD 0000" displays on screen, the left first digital blinks, ask for entering password, factory default set password is "0000"
- ▶ Press   button to enter first digital of password.
- ▶ Repress  button, the second digital blinks
- ▶ Press   button, to enter second digital of password
- ▶ Repress  button, the third digital blinks
- ▶ Press   button, to enter the third digital of password
- ▶ Repress  button, the fourth digital blinks
- ▶ Press   button, to enter the fourth digital of password
- ▶ Repress  button again to access main menu
- ▶ Press   button, to select the main menu
- ▶ Press  button to exit main menu



For example



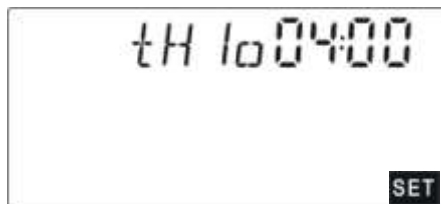

### 4.2 Access submenu

After selecting main menu, do like following access submenu

- ▶ Press  button, to access submenu
- ▶ Press   button to select submenu



For example

- ▶ Press  button again to access program, can adjust parameter value now
- ▶ Press   button, to adjust the value of parameter
- ▶ Press  button, exit program of submenu
- ▶ Press  button again, to exit main menu.

### 4.3 Main menu - THET Timing heating

#### **Function description:**

Electrical heater, gas boiler or oil boiler can be integrated into solar system used as back-up of system, and they can be triggered automatically at preset time by preset temperature. Within a preset time sections, when the temperature (T3) of top part of tank drops below the preset switching-on temperature of this function, back-up heating starts to work, when T3 rises up to the preset turning off temperature, back-up heating is stopped. Within 24 hours, three time sections can be set with this controller.

#### **Factory set:**

The first time section: back-up heating function starts at 4:00 and ends at 5:00 am. Within this time section, the switch-on temperature is 40°C; switch-off temperature is 45°C.

The second time section: from 10:00 to 10:00 am, it means there is no back-up heating in this time.

The third time section: back-up heating function starts at 17:00 and ends at 22:00 pm. Within this time section, the switch-on temperature is 50°C; switch-off temperature is 55°C.

The switch-on temperature adjustable range: 10 °C ~ (OFF-2 °C)

The switch-off temperature adjustable range: (ON+2 °C) ~ 80 °C)

If you want to shut off one timing heating, then you can set the turning on time and turning off time same value (for example, the second time section no this function, then you can set turning on/off time is 10:00 ~ 10:00)

#### **Note:**

When there is no sensor installed in the top part of tank (no T3 sensor), controller will take the signal of T2 (sensor in bottom of tank) automatically to control this function.

When time is outside of the preset time section, back-up heating doesn't work automatically even when the tank temperature reaches the switch –on temperature of heating.

The time in this controlled is 24 hours, when you set time section, the switch-off time of heating should be larger than switch-on time. For example: if you set the switch-on time of heating is at 17:00, but switch-off time of heating is 6:00, then this setting doesn't take effect, that means within this time section, heating function doesn't work. The correct set is like flowing: it should be divided into two time sections, one time section is from 17:00 to 23:59, the other time section is from 00:00 to 06:00.

**Setup steps:**

Under standby status, access main menu THET, until "tHET" displays on screen (detailed see 4.1), then



▶ Press  button, access THET program to set parameter, "tH 1o 04:00" displays on screen, set The switch-on time and temperature of the first time section of heating function.

▶ Repress  button, "04" of hour time blinks on screen.

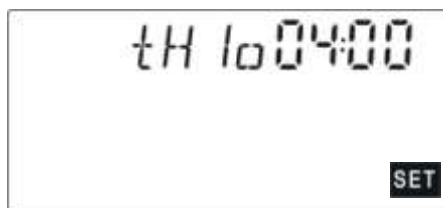

▶ Press   button to adjust hour of time

▶ Repress  button again, "00" of minute time blinks on screen



▶ Press   button to adjust minute of time

▶ Repress  button, temperature "40 °C" blinks on the screen







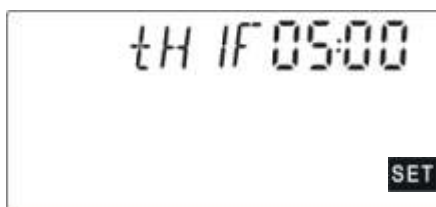

▶ Press   button, to set the switch-on temperature of heating

▶ Then, Press  to exit this set and to access the switch-off time and temperature set

▶ Press  button, "tH 1F 05:00" displays on screen, to set the switch-off time and temperature of first time section of heating function.









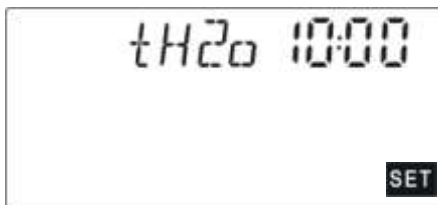



▶ Press  button, "05" of hour time blinks on the screen.

- ▶ Press   button to adjust hour of time
- ▶ Repress  button, "00" of minute time blinks on the screen
- ▶ Press   button to set minute of time
- ▶ Repress  button, temperature "45 °C" blinks on the screen
- ▶ Press   button, to set switch-off temperature of heating
- ▶ Press  to exit this set program, parameters are saved automatically.

▶ Press  button, "tH 2o 10:00" displays on screen, set the switch-on time and temperature of the second time section of heating function.



▶ Press  button, "10" of hour time blinks on the screen.

- ▶ Press   button to adjust hour of time
- ▶ Repress  button, "00" of minute time blinks on the screen.
- ▶ Press   button to adjust minute of time
- ▶ Repress  button, temperature "50 °C" blinks on the screen
- ▶ Press   button to adjust switch-on temperature of heating
- ▶ Then press  exit this set and to access the switch-off time and temperature set

▶ Press  button, "tH 2F 10:00" displays on screen, set the switch-off time and temperature of second time section of heating function.

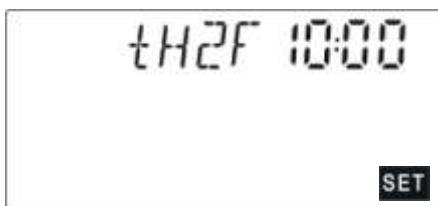



▶ Press  button, "10" of hour time blinks on the screen.

▶ Press   button to adjust hour of time

▶ Re-press  button, "00" of minute time blinks on the screen.

▶ Press   button to adjust minute of time

▶ Re-press  button, temperature "55°C" blinks on the screen

▶ Press   button, to adjust switch-off temperature of heating

▶ Press  to exit this set program, parameters are saved automatically.

▶ Press  button, "tH 3o 17:00" displays on screen, set the switch-on time and temperature of the third time section of heating function.

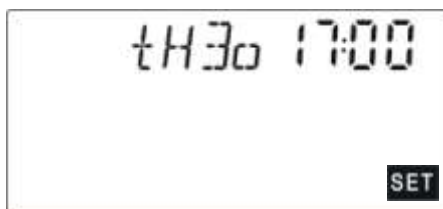



▶ Press  button, "17" of hour time blinks on screen.

▶ Press   button, to adjust hour of time

▶ Re-press  button, "00" of minute time blinks on screen

▶ Press   button, to adjust minute of time

▶ Re-press  button, temperature "50°C" blinks on screen







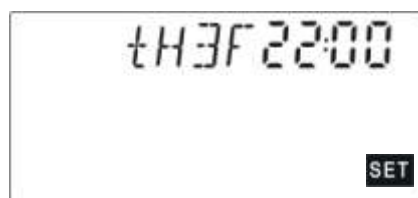

▶ Press   button, to adjust switch-on temperature of heating

▶ Press  to exit this set program and to the switch-off time and temperature set



▶ Press  button, "tH 3F 22:00" displays on screen, set the switch-off time and temperature of the third time section of heating function.



▶ Press  button, "22" of hour time blinks on screen

- ▶ Press   button, to adjust hour of time
- ▶ Re-press  button, “00” of minute time blinks on screen
- ▶ Press   button to adjust minute of time
- ▶ Re-press  button, temperature “55°C” blinks on screen
- ▶ Press   button to adjust switch-off temperature of heating
- ▶ Press  to exit menu, or wait for 20 seconds, set parameters are saved automatically.

**Note:** when no gas or oil boiler is installed in system, but an electrical heater is installed as

back-up device, well then  HEAT heating signal displays on screen. When electrical heater is in operation status, signal  blinks on the screen.

If customer use electrical heater as back-up, please according to the power of electrical heater to equip corresponding safety devices like contactor and breaker with this controller, we strongly recommend equipping with SR801 device with this controller, (SR801 detailed technical data see 10. spare parts)

#### 4.4 DT Temperature difference adjusting function

**Description:**

Solar circuit pump R1 is triggered by the temperature difference function, so long as the temperature difference between collector and tank reaches the switch-on DT, solar circuit pump is triggered.

For example: the switch-on DT is 8°C, switch-off DT is 4°C, if the temperature in the bottom part of tank is 20°C, then just when collector temperature rises up to 28°C, pump is triggered, when collector temperature drops to 24°C, pump is ceased.



**Note:** the switch-on/off DT of 8°C and 4°C are standard system setting according to many years' experience, only in special application cases it needs to be changed, (e.g. far distance heat transferring), normally it is recommend using default set. Switch-on and

switch-off DT are alternating set. To avoid mistake the minimum difference between two temperature differences ( $\Delta T_{on} - \Delta T_{off}$ ) is set as 2 °C.

### Setup steps:

Under standby status, access main menu DT, until “DT” displays on screen (detailed see 4.1), then

▶ Press  button, to access settings program of DT, “DT 1o 08 °C” displays on screen, “08 °C” blinks, the first switch-on temperature difference can be set.



▶ Press   button, to adjust the value of switch-on DT, adjustable range (OFF+2 °C)~20 °C, factory setting is 8 °C.

▶ Press  button to exit this setting.

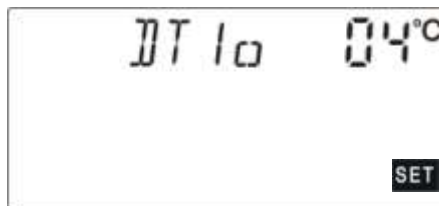
▶ Press  button, “DT 1F 04 °C” displays on screen, the first switch-off temperature difference can be set.



▶ Press  button, “04 °C” blinks.

▶ Press   button to adjust the value of switch-off DT, adjustable range 0 °C~(ON-2 °C), factory set is 4 °C.

▶ Press  to exit menu, or wait for 20 seconds to exit automatically, the setup parameters are saved automatically.

**Note:** according to the selected solar system, maximum two switch-on/off DT groups can be set, they are (DT 1o, DT 1F) (DT 2o, DT 2F), setup steps same like above description.

## 4.5 TEMP Temperature main menu

For every system, the factory set parameters are in the best condition that is fully integrated into the entire solar system. But these parameters can also be set individually to cater the special requirements, please carefully observe the operation data of system components after setting.

**Note:** parameters that can be set depend on the selected system, not all the parameters can be adjusted in a solar system.

Following submenu can be accessed though TEMP main menu.

EM Emergency collector temperature (Emergency switch-off temperature of collector) -----4.5.1  
 CMX Maximum limited collector temperature (collector cooling function) -----4.5.2  
 CMN Low temperature protection of collector -----4.5.3  
 CFR Frost protection of collector -----4.5.4  
 REC Tank re-cooling function -----4.5.5  
 SMX1 Maximum temperature of tank 1 -----4.5.6  
 SMX2 Maximum temperature of tank 2 -----4.5.7  
 MAX1 Maximum turn-off temperature (for solid fuel boiler, heating return and heat transferring between tanks) -----4.5.8  
 MIN1 Minimum turn-on temperature (for solid fuel boiler, heating return and heat transferring between tanks) -----4.5.9

Function	Adjustable range	Factory set	Function exit temperature
<b>EMOF</b> Collector maximum switch-off temperature	(ON+3°C) ~ 200°C	130°C	
<b>EMON</b> Collector maximum switch-on temperature	(OFF-3°C) ~ 197°C	120°C	
CMX Maximum limited collector temperature (collector cooling function)	110 °C~190 °C.	110 °C.	107 °C.
CMN low temperature protection of collector	0 °C~90 °C.	OFF	
CFR frost protection of collector	-10 °C~10 °C.	OFF	
REC Tank recooling function		OFF	
SMX1~2 Maximum temperature of tank 1,2	2 °C~95 °C.	60 °C.	58 °C.
MAX1 Maximum switch-off temperature ( for solid fuel boiler, heating return and heat transfer between tank)	(MIN1+2 °C) ~95 °C.	60 °C.	
MIN1 Minimum switch-on temperature ( for solid fuel boiler, heating return and heat transfer between tank)	10°C~(MAX1-2 °C)	30 °C.	

4.5.1 EM Emergency collector temperature (Emergency switch-off temperature of collector)

**Function description:**

When temperature of collector rises up to the preset maximum switch-off temperature, collector emergency switch-off function is activated. As the result of this function, solar circulation pump is stopped, it avoids the damage of system components caused by over-heated temperature. EMOF parameter is for set maximum switch-off temperature of collector (factory set: 130°C), if the collector temperature rises up to preset EMOF temperature, solar pump is stopped; EMON parameter is for set maximum switch-on temperature of collector (factory set: 120°C), when the collector temperature drops to EMON temperature, solar pump can be triggered again, collector emergency switch-off function is deactivated automatically.

● **EMOF collector maximum switch-off temperature**

Select submenu EMOF, “EMOF 130°C” displays on the screen.

- ▶ Press “ SET” button, parameter 130°C blinks on the screen.
- ▶ Press “ ▲ ” “ ▼ ” button, to adjust the **EMOF** temperature, adjustable range: ( ON +3°C)~200°C, factory set is 130°C.
- ▶ Re-press “SET” button, activate and deactivate this function, if deactivate the function, “EMOF - -” displays on screen.
- ▶ Press “ ESC” button to exit menu, or wait for 20 seconds to exit automatically, set parameter is saved automatically.



● **EMON collector maximum switch-on temperature**

Select submenu EMON, “EMON 120°C” displays on the screen.

- ▶ Press “ SET” button, parameter 120°C blinks on the screen.
- ▶ Press “ ▲ ” “ ▼ ” button, to adjust the **EMON** temperature, adjustable range: ( OFF-3°C)~200°C, factory set is 120°C.
- ▶ Re-press “SET” button, activate and deactivate this function, if deactivate the function, “EMON- -” displays on screen.
- ▶ Press “ ESC” button to exit menu, or wait for 20 seconds to exit automatically, set parameter is saved automatically.



☀️ ⚠️ These two signals display on the screen, means collector emergency switch-off function is activated, and tank temperature rises up to its maximum permitted

temperature.



 Only this signal displays on the screen, means this function is activated, but tank temperature doesn't rise up to its maximum temperature.

#### 4.5.2 CMX Maximum limited collector temperature (collector cooling function)

##### Description:

The collector cooling function delays the vaporization of the heat transfer fluid. Shortly before reaching the maximum temperature of the collector, the solar pump starts working in order to cool down the heat transfer fluid using the losses occurring in pipelines and storage cylinder.

When tank temperature rises to its preset maximal temperature, solar circuit pump is ceased compulsively even the temperature is satisfied. If the sunshine is very good, as a result collector temperature will rise continuously, when collector temperature rises up to its maximal temperature, solar pump will be triggered again even at the case that tank temperature is already to its maximal temperature. And solar pump works until the temperature of collector drops since this reversed circulation or when tank temperature rises its emergency temperature (95°C).

When  displays,  blinks on screen, it indicates that tank emergency temperature reaches, tank temperature is  $\geq 95^{\circ}\text{C}$ .



##### Setup steps:

To access main menu TEMP, then select submenu CMX "CMX 110°C" displays on screen



▶ Press  button, parameter "110 °C." blinks.

▶ Repress  button, activate and deactivate this function, if deactivate the function, "CMX - - -" displays on screen.

▶ Press   button, to adjust the collector protection temperature, adjustable range (110 °C~190 °C.), factory set is 110 °C.

▶ Press  button to exit the menu or wait for 20 seconds to exit automatically, parameters are saved automatically.

 CMX signal displays on screen, it indicates that this function is in activated.

### 4.5.3 CMN Low temperature protection of collector

#### Description:

When the temperature of collector is below set CMX temperatures, solar circuit pump is ceased, even when the temperature difference between collector and tank exceeds switch-on temperature difference, solar pump doesn't work yet. When temperature of collector is 3 °C higher than the set CMX temperature, solar circuit pump is restarted, controller exits this program.



#### Setup steps:

To access main menu TEMP, then select submenu CMN, "CMN-----" displays on screen, default set is off.

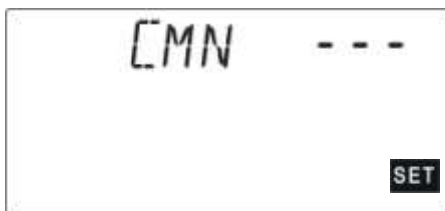
▶ Press  button, default off signal "- - -" blinks on screen.



▶ Repress  button, to activate and deactivate this function

▶ Press   button, to adjust the low protection temperature of collector CMN, adjustable range (00 °C~90 °C.), after activate the function, factory set is 10 °C.

▶ Press  button to exit the menu or wait for 20 seconds to exit automatically, parameters are saved automatically.



CMN signal displays on screen, it indicates that this function is in activated.

### 4.5.4 CFR Frost protection of collector

#### Description:

In winter when the temperature of collector is below the preset frost protection temperature (factory set is 4 °C.), solar circuit pump is triggered, and when collector temperature is 3 °C above the preset protection temperature, solar pump is stopped, this function is deactivated automatically. In case that this function is activated, when tank temperature ( T2) drops to 6 °C, electrical heater is triggered immediately and heats tank up to 20 °C or when this function is deactivated, then electrical heater stops to work.

This function is used in system, which use water as heat transfer liquid, to avoid the freezing



of solar heat transfer fluid.

**Setup steps:**

To access main menu TEMP, then select submenu CFR, “CFR ----” displays on screen, default set is off.

▶ Press  button, default off “- - -” blinks.

▶ Repress  button, to activate or deactivate this function

▶ Press   button, to adjust the frost protection function, adjustable range is (-10 °C.~10 °C), after function activated, default set is 4 °C.

▶ Press  button to exit the menu or wait for 20 seconds to exit automatically, parameters are saved automatically.



CFR signal displays on screen, it indicates that this function is in activated.

**Note:** this function is only available in special solar system without anti-freezing liquid; this kind of system is only suitable in area where the ambient temperature is near to 0 °C in only few days. If safety requirement is very high and anti-freezing is necessary, we suggest using suitable anti-freezing liquid to avoid frost problem.

### 4.5.5 REC Tank re-cooling function

**Description:**

If tank temperature is over tank’s maximum temperature, and at the same time, collector temperature is 5°C lower than tank temperature, then solar pump is triggered, through this reversed circulation, tank temperature is reduced by heat loss occurs in collector, solar pump keep in working until tank temperature drops below its maximum temperature.

**Setup steps:**

To access main menu TEMP, then select submenu REC, “REC OFF” displays on screen, default set is off.

▶ Press  button, “OFF” blinks on screen

▶ Repress  button to activate or deactivate



this function, after function activated, "REC OFF" displays on screen

▶ Press  button to exit the menu or wait for 20 seconds to exit automatically, parameters are saved automatically.

 REC signal displays on screen, it indicates that this function is in activated.

#### 4.5.6 SMX1 Maximum temperature of tank 1

##### Description:

When the DT between collector T1 and Tank 2 caters the switch-on DT of circulation, solar pump is triggered, but in order to avoid the high temperature inside tank, controller will check whether the temperature (T3) of top part of tank is higher than maximum temperature of tank, when T3 is larger than SMX1, solar pump is ceased even at the case that DT caters condition. When tank temperature drops and is 2 °C below the SMX1, solar pump restarts when DT caters condition.



##### Setup steps:

To access main menu TEMP, then select submenu SMX1, "SMX1 60 °C" displays on screen.

▶ Press  button, parameter "60 °C"blinks

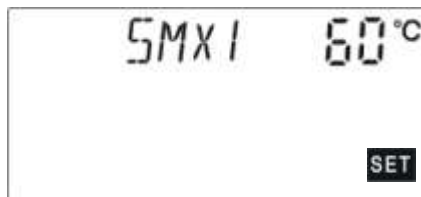
▶ Repress  button to activate and deactivate this function, if function deactivated, "SMX1 - - -" displays on the screen.



▶ Press   button to adjust the value of maximum temperature of tank1 adjustable range is (2 °C~95 °C) , default set is 60 °C

▶ Press  button to exit the menu or wait for 20 seconds to exit automatically, parameters are saved automatically.

 SMX signal displays on screen, it indicates that this function is in activated.

#### 4.5.7 SMX2 Maximum temperature of tank 2



##### Setup steps:

To access main menu TEMP, then select submenu SMX2, "SMX2 60 °C" displays on screen.

▶ Press  button, parameter “60 °C” blinks

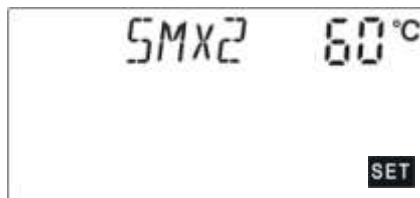
▶ Re-press  button to activate and deactivate this function, if function deactivated, “SMX2 - - -” displays on the screen.



▶ Press   button to adjust the value of maximum temperature of tank1 adjustable range is(2 °C~95 °C), default factory set is 60 °C

▶ Press  button to exit the menu or wait for 20 seconds to exit automatically, parameters are saved automatically.

#### 4.5.8 MAX1 Maximum turn-off temperature (for solid fuel boiler, heating return and heat transferring between tanks)

##### Description:



Through setting the maximum turn-on/off temperature, controller can trigger circuit pump, therefore, tank can be heated by solid fuel boiler.

When temperature of top part of tank is below the switch-on temperature value or temperature inside solid fuel boiler is between its minimum and maximum value (MIN 1 and MAX1), then circuit pump is triggered. When tank temperature rises up to switch-off value or it exceeds the minimum and maximum value (< MIN1 or > MAX1), circuit pump is ceased.

##### Setup steps:

To access main menu TEMP, then select submenu MAX1, “MAX1 60 °C” displays on screen.

▶ Press  button, parameter “60 °C” blinks.

▶ Press   button, to adjust the maximum switch-off temperature, adjustable range is (MIN1+2 °C)~95 °C, factory default set is 60 °C

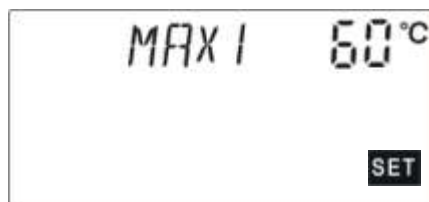



▶ Press  button to exit the menu or wait for 20 seconds to exit automatically, parameters are saved automatically.

4.5.9 MIN1 Minimum turn-on temperature (for solid fuel boiler, heating return and heat transferring between tanks)

**Setup steps:**

To access main menu TEMP, then select submenu MIN1, “MIN1 30 °C” displays on screen.

▶ Press  button, parameter “30 °C” blinks.

▶ Press   button, to adjust the minimum switch-on temperature, adjustable range is 10 °C~ (MAX1-2 °C), factory default set is 30 °C



▶ Press  button to exit the menu or wait for 20 seconds to exit automatically, parameters are saved automatically.

**4.6 FUN Auxiliary function**

The auxiliary function of this controller can be set under “FUN” submenu; it is possible to activate several auxiliary functions.

**Note:**

Sometimes, your selected function need an extra signal input to connect temperature sensor or an extra output to connect pump or electromagnetic valve, when all the inputs and outputs have been occupied, the required outputs will not be activated. In this case, for your selected solar system, in “FUN “submenu, some functions are deactivated. Hence, for different system, activated or deactivated status for following auxiliary functions in submenu is also different.

DVWG Anti-Legionella function-----	4.6.1
CIRC Temperature controlled hot water circulation pump -----	4.6.2
nMIN Solar circuit pump speed adjusting (RPM speed controlling-----	4.6.3
DTS Standard temperature difference (for circuit pump speed adjusting-----	4.6.3.1
RIS Increase rate (for circuit pump speed adjusting) -----	4.6.3.2
OHQM Thermal energy measuring-----	4.6.4
FMAX Flow rate-----	4.6.4.1
MEDT Type of heat transfer liquid-----	4.6.4.2
MED% Concentration of anti-freezing liquid -----	4.6.4.3
PRIO Priority logic of tank-----	4.6.5
TRUN Heating loading- time-----	4.6.5.1
TSTP Heating interval- time-----	4.6.5.2
<b>INTV</b> Pump interval function -----	4.6.6

ISTP Pump interval time-----	4.6.6.1
IRUN Pump running time-----	4.6.6.2
BYPA High temperature by-pass function (tank temperature automatically adjusting) -----	4.6.7



#### 4.6.1 DVWG Anti-Legionella function

##### Description:

In order to avoid occurring bacteria in water tank when the temperature of tank is lower for a long time, controller will check the temperature of tank every 7 days in a period automatically, if the temperature of tank is never over 70°C during this period, then at the factory set default time of 01:00 on the seventh day of the period auxiliary heating system is triggered automatically to heat water until it rises up to 70°C, bacteria is killed by high temperature, function is deactivated.

##### Setup steps:

To access main menu FUN, then select submenu DVWG, “DVWG OFF” displays on screen. Default set is “OFF”.

- ▶ Press  button, parameter” OFF” blinks on the screen.
- ▶ Repress  button, “DVWG ON” blinks on the screen, function is triggered.
- ▶ Press  button to exit the menu or wait for 20 seconds to exit automatically, parameters are saved automatically.

#### 4.6.2 CIRC Temperature controlled hot water circulation pump

##### Description:

Solar system can provide temperature-controlled hot water circulation function, this function needs an extra hot water circulation pump (connect output port R3) and a sensor, which is installed on the return pipe of hot water (connect input port T5). When the temperature signal of sensor T5 is less than the preset turning on temperature of circulation pump, the hot water circulation pump (R3) triggers and works till the temperature exceeds the turning off temperature.

**Factory set:** the desired hot water return temperature is 40°C, when T5 drops to 35°C, circulation pump R3 is triggered, when T5 rises up to 40°C, circulation pump R3 is ceased.

**Condition for triggering hot water circulation pump:** only when tank temperature T2 is 7°C higher than the required hot water temperature, hot water circulation pump just can be

triggered.

**Note:** in order to avoid large measuring error, the sensor T5 on hot water return pipe should be installed 1.5m far away from tank. This function isn't available in all 50 systems.



**Setup steps:**

To access main menu FUN, then select submenu CIRC, "CIRC-----" displays on screen, factory set is off.

▶ Press  button, parameter "- - -" blinks on screen.



▶ Re-press  button, parameter "40°C" blinks on screen

▶ Press   button, to adjust the temperature of hot water return, adjustable range is (2°C~95°C), after function is activated, factory set is 40°C.

▶ Press  button, "- - -" blinks on screen, function is deactivated

▶ Press  button to exit the menu or wait for 20 seconds to exit automatically, parameters are saved automatically.

**4.6.3 nMIN Solar circuit pump speed adjusting (RPM speed controlling)**

**Description:**

R1 and R2 outputs can be configured to function either as RPM controlled output or simple switch output. When this function is activated, the output is RPM controlled output; when this function is deactivated, R1 is normal switch output.

**Normal switch output:** circuit pump speed controlling is deactivated, pump is operated with a fixed speed, and flow rate is not changed.



**RPM control output:** (speed controlling is activated), the control system attempts to maintain a constant temperature difference between collector and tank. The pump performance is continuously adjusted and the volume flow pumped is increased or reduced, depending on the temperature difference.

**Setup steps:** To access main menu FUN, then select submenu nMIN, "nMIN 30" displays

on screen.

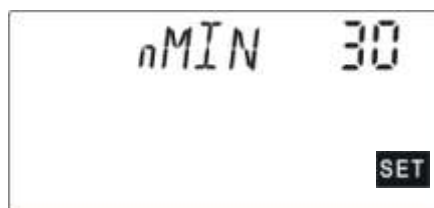
▶ Press  button, parameter “30” blinks on the screen



▶ Press   button, to adjust speed of circuit pump, adjustable range (30~100%), factory set is 30%

▶ Press  button to exit the menu or wait for 20 seconds to exit automatically, parameters are saved automatically.

#### 4.6.3.1 DTS Standard temperature difference (for circuit pump speed adjusting)

##### Description:



When the switch-on temperature difference ( $\Delta T$  ON) reaches, solar pump is triggered, and then within 20 seconds, pump speed reaches to its minimum speed 30%. Whereafter, controller checks continuously, when the standard temperature difference reaches, the speed of pump increases one grade (10%), temperature difference RIS increases every 1°C, speed of pump increases 10% until it reaches its maximum speed 100%. Through setting the temperature difference increase rate can achieve the pump speed. If temperature difference drops to the switch-off TD, circuit pump is ceased.

##### Setup steps:

To access main menu FUN, then select submenu DTS, “DTS 08°C” displays on the screen



▶ Press  button, parameter “08°C” blinks on the screen

▶ Press   button, to adjust standard TD, adjustable range (2°C~30°C), factory set is 08°C

▶ Press  button to exit the menu or wait for 20 seconds to exit automatically, parameters are saved automatically.



#### 4.6.3.2 RIS Increase rate (for circuit pump speed adjusting)

##### Setup steps:

To access main menu FUN, then select submenu RIS, "RIS 01°C" displays on screen.

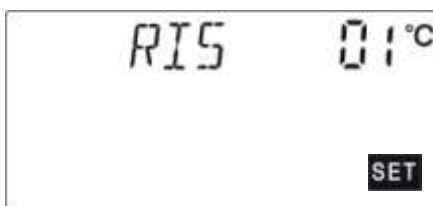
▶ Press  button, parameter "01°C" blinks on the screen



▶ Press   button, to adjust increase rate of ( RIS ) of temperature difference, adjustable range (1 °C~20 °C), factory set is 1°C

▶ Press  button to exit the menu or wait for 20 seconds to exit automatically, parameters are saved automatically.

#### 4.6.4 OHQM Thermal energy measuring

##### Description:

Controller has function for measuring the thermal energy; it can measure the energy which from collector transfers to tank. For the sake of measuring, the temperature on going and return pipe should be checked, and an extra flow meter should be installed on the circulation pipe also, for measuring the flow rate.

The thermal energy through solar system is calculated with measured parameter temperature (T1, T0) and flow rate. Thermal energy got in current day displays in DKWh, accumulative thermal energy displays in kWh or MWh.

OHQM thermal energy balance function: factory set is OFF.

##### Setup steps:

To access main menu FUN, then select submenu OHQM, "OHQM OFF" displays on screen.

▶ Press  button, parameter "OHQM OFF" blinks on the screen



▶ Repress  button, to activate this function, "OHQM ON" blinks on the screen





▶ Press  button to exit the menu or wait for 20 seconds to exit automatically, parameters are saved automatically.

Thermal energy got in current day, accumulative thermal energy and operation time of pump can be reset,



**Operation steps:** under standby status, doing like following

▶ Press   button, select to check the thermal energy of current day, “DKWH XX” “SET” displays on the screen.

▶ Press  button for 3 seconds, buzzer makes 3 times “du-----” , the daily thermal energy is cleared, daily thermal energy is reset to “00”.

▶ Press   button, select to check accumulative thermal energy, “KWH XX” or “MWH XX” “SET” displays on the screen.

▶ Press  button for 3 seconds, buzzer makes 3 times “du-----” , the sum thermal energy is cleared, accumulative thermal energy is reset to “00”.

▶ Press   button, select to check operation time of pump, “hP XX” “SET” displays on the screen.

▶ Press  button for 3 seconds, buzzer makes 3 times “du-----” , the operation time of pump is cleared, it is reset to “00”.

**Note:** only when the thermal energy balance function is activated, operation time of circulation pump function just can be triggered.



#### 4.6.4.1 FMAX Flow rate

FAMX: Flow rate L/min. adjustable range: (0.1~20) L/min, every time increases 0.1L/min, factory set is 2.0L/min

**Setup steps:**

To access main menu FUN, then select submenu FMAX, “FMAX 2.0” displays on screen.

▶ Press  button, parameter “2.0” blinks on the screen

▶ Press   button to adjust parameter of flow rate. adjustable range (0.1~20)

▶ Press  button to exit the menu or wait for



20 seconds to exit automatically, parameters are saved automatically.

#### 4.6.4.2 MEDT Type of heat transfer liquid

MEDT: type of heat transfer liquid, adjustable range (00~03), factory set : 01

Type of heat transfer liquid:

00: Water

01: Propylene glycol





02: Glycol

03: Tyfocor LS/G-LS



##### Setup steps:

To access main menu FUN, then select submenu MEDT, "MEDT 01" displays on screen.

- ▶ Press  button, parameter "01" blinks on the screen.
- ▶ Press   button, to adjust type of heat transfer liquid, adjustable range (00~03)
- ▶ Press  button to exit the menu or wait for 20 seconds to exit automatically, parameters are saved automatically.





#### 4.6.4.3 MED% Concentration of heat transfer liquid

MED% Concentration of heat transfer liquid (volume percentage %), depending on the type of heat transfer liquid, adjustable range (20 ~70), factory set 40%

##### Setup steps:

To access main menu FUN, then select submenu MED%, "MED% 40" displays on screen.



- ▶ Press  button, parameter "40" blinks on the screen
- ▶ Press   to adjust concentration, adjustable range(20~70)
- ▶ Press  button to exit the menu or wait for 20 seconds to exit automatically, parameters are saved automatically.

#### 4.6.5 PRIO Priority logic of tank

##### Description:

If 2 tanks are used in a solar system, a storage priority must be set; the storage priority sets the priority according to which tanks are loaded. One must decide between first-priority and second-priority storage tank.

If the first-priority storage tank reaches its switch-on temperature difference before the second-priority storage tank does, then the first priority storage tank is loaded until its maximum storage temperature is reached, only then second-priority storage tank should be loaded.

If the second-priority tank reaches its switch-on temperature difference before the first-priority tank does, then first of all the second-priority tank is loaded, however, only until the first-priority tank has reached its switch-on temperature difference. In order to determine this value, the switch-on conditions of first-priority tank are constantly checked while the second-priority storage tank is loaded.

In addition, the solar circuit is put to a stop and the increase of temperature in the collector array is monitored during the test-on time. If the switch-on temperature difference of the first-priority tank is reached, then the first-priority tank is loaded. If this temperature difference is not reached, then the second-priority tank is loaded, this test is repeated every 15 minutes.

When the device is delivered, the time interval and the test on time are set to 15 minutes and 2 minutes (factory set), but can be changed later on.



The selection that which tank is priority and corresponding parameter are only available in the system which has over two tanks, if the parameter of priority is set as 00, that means the tank priority function is deactivated, then all tank can be loaded at the same time. (01 means tank1 is priority tank, 02 means tank 2 is priority tank).

##### Setup steps:

To access main menu FUN, then select submenu PRIO, "PRIO 01" displays on screen.

► Press  button, parameter "01" blinks on screen.



► Press   button, to adjust the priority of tank, adjustable range: 00~02, factory set is 01.

► Press  button to exit the menu or wait for 20 seconds to exit automatically, parameters are saved automatically.

	Factory set	Adjustable range
Priority tank	01	00-03
Heating interval-time ( TSTP)	2 minutes	01-30 minutes
Heating loading- time ( TRUN)	15 minutes	01-30 minutes

**4.6.5.1 TRUN Heating loading- time**



**Description:**

Heating interval time (TSTP) and heating loading- time (TRUN) are two parameters used in tank priority function. Controller constantly checks whether the temperature difference between collector and tank caters the switch-on DT, if the DT between collector and first-priority tank is not reached its switch-on DT, then it checks the DT between collector and second-priority tank, if it reaches switch-on DT, then second-priority tank is loaded, but howlong time the second-priority tank can be loaded, this loading-time is monitored by the so-called heating loading-time (TRUN), if this TRUN time run out, then the loading of second-priority tank is intermitted. Controller checks the DT between tank and collector continuously, in the so-called heating interval time (TSTP), controller will check whether DT between collector and the first-priority tank caters the switch-on DT, if it is still not, then second priority tank is heated continuously, if DT caters, then the first-priority tank is loaded, and the heating loading time function is deactivated.

**Setup steps:**

To access main menu FUN, then select submenu TRUN, "tRUN 15" displays on screen.

▶ Press  button, parameter "15" blinks on screen.

▶ Press   button to adjust the loading time, adjustable range : 01~30 minutes, factory set is 15 minutes.



▶ Press  button to exit the menu or wait for 20 seconds to exit automatically, parameters are saved automatically.

#### 4.6.5.2 TSTP Heating interval- time

**Setup steps:**

To access main menu FUN, then select submenu TSTP, "tSTP 02" displays on screen.

▶ Press  button, parameter "02" blinks on screen.

▶ Press   button to adjust the loading time, adjustable range : 01~30 minutes, factory set is 2 minutes.



▶ Press  button to exit the menu or wait for 20 seconds to exit automatically, parameters are saved automatically.

#### 4.6.6 INTV Pump interval function

**Description:**

This function is useful when collector sensor isn't installed in collector (sensor installed on the outlet pipe of collector). In order to measure the actual temperature of collector, within the preset interval, solar pump is triggered like pulse, so that the hot water inside collector can flow to the pipe, where sensor is mounted, as the result, the actual temperature of collector is measured. It is unnecessary to activate this function in all time, you can use it within a preset time section, default set time is 06:00 ~20:00.

**Setup steps:**

To access main menu FUN, then select submenu INTV, "INTV OFF" displays on screen.

▶ Press "SET" button, parameter "OFF" displays and blinks, factory set is "OFF"

▶ Press "+" "-" button, to activate this function, "INTV ON" displays on the screen.

▶ Press "ESC" button to exit the menu or wait for 20 seconds to exit automatically, parameters are saved automatically.

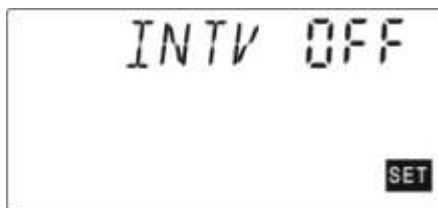

#### 4.6.6.1 ISTP Pump interval- time

##### Setup steps:

To access main menu FUN, then select submenu ISTP, "ISTP 30" displays on screen.

▶ Press "SET" button, parameter "30" blinks on screen, factory set is "30" minutes.

▶ Press "+" "-" button to adjust the loading time, adjustable range: 2~60 minutes,

▶ Press "ESC" button to exit the menu or wait for 20 seconds to exit automatically, parameters are saved automatically.



#### 4.6.6.2 IRUN Pump running time

##### Setup steps:

To access main menu FUN, then select submenu IRUN, "IRUN 10" displays on screen.

▶ Press "SET" button, parameter "10" blinks on screen, factory set is 15 second. .

▶ Press "+" "-" button to adjust the running time, adjustable range: 5~120 seconds

▶ Press "ESC" button to exit the menu or wait for 20 seconds to exit automatically, parameters are saved automatically.



#### 4.6.7 BYPA High temperature by-pass function (tank temperature automatically adjusting)

##### Description:

High-temperature bypass role is independent of the solar system's operation; the extra thermal energy of tank can be transferred to other application through this function, and thereof to keep a constant tank temperature. In order to transfer this extra energy, it needs an extra pump or electromagnetic valve. (Connect to output port R4).

**For example:**

If we set the temperature of bypass is 70 °C, then when tank temperature (T2) rises up to 71°C, this by-pass function is triggered, electromagnetic valve or circuit pump (R4) and TD controlled circuit pump (R1) will be triggered simultaneously. When tank temperature (T2) drops to 67°C, electromagnetic valve or circuit pump (R4) and TD controlled circuit pump (R1) will be ceased simultaneously.



**Setup steps:**

To access main menu FUN, then select submenu BYPR, “BYPR-----” displays on screen. Default set is “OFF”.

▶ Press  button, “- - -”blinks on screen, default set is “OFF”



▶ Repress  button, to activate by-pass function, “BYPR 95 °C” displays on the screen. (“95 °C” blinks)

▶ Press   button to adjust this parameter, adjustable range (5 °C~120 °C)

▶ Press  button to exit the menu or wait for 20 seconds to exit automatically, parameters are saved automatically.



This signal displays on the screen, it indicates by-pass function is activated.

#### 4.7 HND Manual mode

When using this controller first time or when debugging this controller, output of this controller (R1, R2, R3, R4, R5) can be triggered manually.

**Setup steps:**

To access main menu HND, detailed steps see 4.1

▶ Press  button, “HND1 OFF” displays on the screen, R1 output manually set.

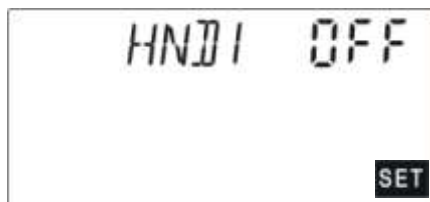

▶ Repress  button, “HND1 ON” displays on the screen, R1 output is switched-on.

▶ Repress  again, “HND1 OFF” displays, R1 output is switched-off .

▶ Press  to exit R1 set program.

▶ Press  button, “HND2 OFF” displays on the screen, R2 output manually set.



▶ Press  button, “HND2 ON” displays on the screen, R2 output is switched-on.

▶ Repress  again, “HND2 OFF” displays, R2 output is switched-off

▶ Press  to exit R2 set program

▶ Press  button, “HND3 OFF” displays on the screen, R3 output manually set

▶ Press  button, “HND3 ON” displays on the screen, R3 output is switched-on

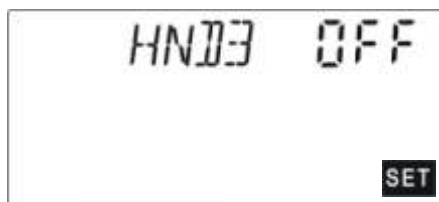

▶ Repress  again, “HND3 OFF” displays, R3 output is switched-off

▶ Press  to exit R3 set program

▶ Press  button, “HND4 OFF” displays on the screen, R4 output manually set

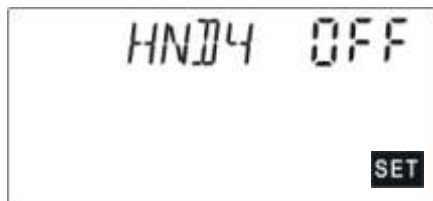

▶ Press  button, “HND4 ON” displays on the screen, R4 output is switched-on

▶ Repress  again, “HND4 OFF” displays, R4 output is switched-off

▶ Press  to exit R4 set program

▶ Press  button, “HND5 OFF” displays on the screen, R5 output manually set

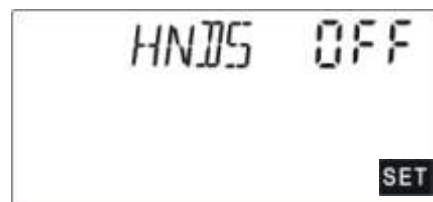

▶ Press  button, “HND5 ON” displays on the screen, R5 output is switched-on

▶ Repress  again, "HND5 OFF" displays, R5 output is switched-off

▶ Press  to exit R5 set program

**Note:** when manual mode is activated,  signal displays on the screen, after 15 minutes all outputs are switch-off, controller exits manual mode automatically.

#### 4.8 PASS Password setting

##### Setup steps:



To access main menu PASS, detailed steps see 4.1

▶ Press  button, "PWDC 0000", the left digital blinks, ask for to enter the password, factory set is "0000"



▶ Press   button to enter the first digital

▶ Repress  button, the second digital blinks

▶ Press   button to enter the second digital

▶ Repress  button, the third digital blinks

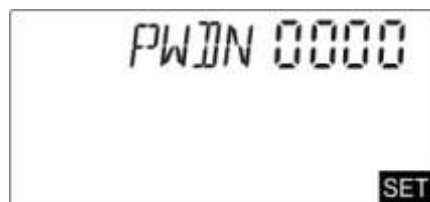

▶ Press   button to enter the third digital

▶ Repress  button, the fourth digital blinks

▶ Press   button to enter the fourth digital

▶ Press  button, "PWDN 0000" displays on the screen, ask for entering a new password, doing like above to enter the new password



▶ Press  button, "PWDG 0000" displays on the screen, ask for reentering the new



password, doing like above to reenter the new password, "PWOK" displays on the screen to indicate reentering password successfully.

- ▶ Press  button to exit set program. Or wait for 20 seconds to exit automatically.



### **Warning !**

If the password is forgot, it is not possible to recover, but you can recover the password to factory set, then you can reedit a password like above descript steps, doing like following to recover to factory set.

- ▶ Open the connection terminal cover,
- ▶ press  and hold down, then repress the reset button, which is on the terminal plate.
- ▶ Buzzer makes "du-----" 3 times, then release  button. Controller recovers to factory set, a new password can be reset now.



## **4.9 RSET Recovery factory setting**

### **Setup steps:**

To access main menu REST, detailed steps see 4.1

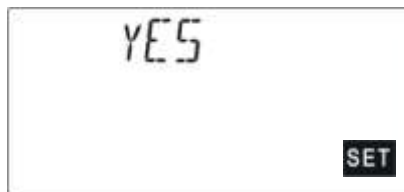
- ▶ Press  button, "YES" displays on the screen.





- ▶ Hold down  button, buzzer makes "du-----" 3 times, then release  button. Controller recovers to factory set, new paramters can be reset now.

- ▶ Press  button to exit set program. Or wait for 20 seconds to exit automatically.

## **4.10 On/OFF button**

Under the standby status,

- ▶ Press  button for 3 seconds; controller is switched off, "OFF" displays on the screen.
- ▶ Repress  button, controller is switched-on again.

## 4.11 Holiday function

### Description:

This function activates in night, solar liquid will flow from storage tank to collector to cool the tank, and therefore to prevent high thermal loads problem of the solar system due to completely heated storage tank. The function is activated at night between 10 pm and 6 am, when the collector temperature drops 8K below the storage tank temperature (T2), solar circuit pump starts to work; when the temperature of collector is 2°C below the tank temperature, and solar circuit pump is ceased.

### Activate this function if:

You intend to be absent for an extended period (holiday)  
No hot water is required for an extended period.

The function is deactivated when the temperature in lower section of storage tank falls down to 35°C.

### Activate/ deactivate this function:

▶ Press  button for a long time until the signal of holiday function displays on the screen, and then holiday function is activated.

▶ Repress  button, signal disappears, holiday function is deactivated.

### Note:

This function is only activated when you are not at home for long time, when you come back; please make sure to deactivate it.

## 4.12 Manual heating



### Description:

Electrical heater, gas or oil boiler can be as back-up devices in a solar system, this controller can achieve constant temperature controlling, when controller gets temperature signal of top part tank ( T3) is 2°C below the setting temperature, back-up heating will be triggered. When temperature of top part tank (T3) reaches to the setting temperature, heating is ceased.

Conditions for triggering manual heating function: the setting temperature should be 2°C over the tank temperature.

**Activate/deactivate the function:**

▶ Press  button, temperature “60°C” blinks on the screen.

▶ Press   button to adjust switch-on temperature, adjustable range 10°C~80°C, factory set is 60°C.

After 20 seconds, this function is activated, signal  displays on the screen, and



Heating signal  blinks also.

▶ Press  button to switch-off manual heating function.

**Note:** manual heating can only heat tank one time, after manual heating is triggered, when temperature of tank reaches to the setting temperature, manual heating ceases, and manual heating function will be deactivated automatically, if customer wants to heat again, you need redo according to above steps.

#### 4.13 Temperature query function

Under standby status,

▶ Press   button can check the value of temperature sensor (T0~ T5), pump speed ( n %), accumulative operation time of circuit pump (Hp), daily thermal energy ( DKWH), accumulative thermal energy ( KWH) or ( MWH), week and time.

When checking temperature, “T0 – T5” will displays one by one, corresponding sensor signal  blinks.

**Note:** due to difference system the values you can check are different.

Value of accumulative operation time of circuit pump (Hp), daily thermal energy (DKWH) and accumulative thermal energy (KWH) or (MWH) can only be checked after triggering of QHQM thermal energy balance function.

## 5. Protection function

### 5.1. Memory protection

In case power failure occurs, controller keeps the parameter settings unchanged.

### 5.2. Anti- dry heating protection

In case that no enough water is in tank when electrical heating is in operation, in order to avoid the damage of electrical booster caused by dry heating, controller will start the anti-dry heating protection, “EE” displays on screen and controller switches off all outputs. In this case, it ought to switch off power supply, check and resolve the problems, and then switch on the power, controller restarts to work normally.

### 5.3 Screen protection



When no any press on button for 3 minutes, screen protection is activated automatically, and then LCD lighting lamp is switched-off. Through press any button to light LCD lamp again.







## 6. Trouble shooting

### 6.1 Trouble protection

a. When there is a break or short circuit between the connection of temperature sensors, controller switches off the corresponding functions and no more output signals are given, at the same time error signals  are showed on the display.



If control unit does not work correctly, please check following points.

► Press   button to check error code, “” signal displays on the LCD screen

Error message on LCD screen	Meaning	Cause of error	Error rectification
 T0 ---	T0 sensor problem	Sensor wiring interrupted, not connected or short circuit	Check resistance value, replace
	Thermal measuring function is switched-on	T0 sensor not connected	Connect T0 or switch-off this function (OHQM)
 T1 ---	T1 sensor problem	Sensor wiring interrupted, not connected or short circuit	Check resistance value, replace
 T2 ---	T2 sensor problem	Sensor wiring interrupted, not connected or short circuit	Check resistance value, replace
 T3 ---	T3 sensor problem	Sensor wiring interrupted, not connected or short circuit	Check resistance value, replace
 T4 ---	T4 sensor problem	Sensor wiring interrupted, not connected or short circuit	Check resistance value, replace
 T5 ---	T5 sensor problem	Sensor wiring interrupted, not connected or short circuit	Check resistance value, replace
	Temperature controlled hot water circulation function is switched-on	T5 not connected	Connect T5 or switched-off this function (CIRC)

## 6.2 Trouble checking

The controller is quality product, conceived for years of continuous trouble-free operation. If a problem occurs, the cause of the problem very often lies not in the controller but in the peripheral components. The following description of some well-known problems should help the installer and operator to isolate the problem, so that the system can be place back into operation as quickly as possible and to avoid unnecessary costs. Of course, not all possible problems can be listed here. However, most of the normal problems encountered with the controller can be found in the list below, only return the controller to seller when you are absolutely sure that none of the problems listed below is responsible for the fault.

Symptoms	Secondary symptoms	Possible cause	Procedure
Controller does not appear to function at all	Display shows nothing, no display illumination	Controller power supply is interrupted or program is out of work	Check the controller power cable Press reset button
The solar pump doesn't operate, despite the fact that switch-on conditions are satisfied	The pump symbol in the display blinks	Pump power supply is interrupted	Check the pump power cable
Pump doesn't operate	The pump symbol in the display doesn't blink.  Lighted or  blinks	The maximum storage tank temperature (SMX1) has been reached The maximum collector temperature (EM) has been reached.	No fault
	 T1----- Error message displays on the screen	Fault (short circuit or open circuit) in a temperature sensor	On the controller, request the current values from all connected temperature sensors, replace all defective sensors and /or cabling.

**Separated and Pressurized Solar Controller SR618C6 Manual**

The solar pumps operated, despite the fact that the switch-on conditions are not satisfied.	The pump symbol in the display blinks.	Holiday function or Frost protection function or tank recooling function is activated.	No problem, it is normal. If necessary to deactivate the corresponding functions.
one function can't be activated	There is no function selection in submenu	All inputs and outputs are used; inputs and outputs can not be used doubly.	No fault on controller



**Warning!**

A potentially defective sensor can be checked using an ohmmeter. To do this, the sensor must be disconnected, its resistance measured, and the value compared with the figures in the table below, small deviation ( $\pm 1\%$ ) is acceptable, (**Note: remove the device from the mains supply before opening the case**)

PT1000 resistance value

PT1000 resistance value

°C	0	10	20	30	40	50	60	70	80	90	100	110	120
Ω	1000	1039	1077	1116	1155	1194	1232	1270	1309	1347	1385	1422	1460

°C	0	10	20	30	40	50	60	70	80	90	100	110	120
Ω	33620	20174	12535	8037	5301	3588	2486	1759	1270	933	697	529	407

NTC 10K B=3950 resistance value

**7. Quality Guarantee**

Manufacturer provides following quality responsibilities to end users: within the period of quality responsibilities, manufacturer will exclude the failure caused by production and material selection. A correct installation will not lead to failure. When a user takes incorrect handling way, incorrect installation, improper or crud handling, wrong connection of sensor in system and incorrect operation, the quality responsibility is invalid for them.

The warrantee expires within 24 months after the date of purchasing the controller.

## **8. Technical data**

- Appearance of controller: see product itself ( dimension: 210mm x145mm x48mm)
- Power supply: **AC230V ±10%**
- Power consumption: < 3W
- Accuracy of temperature measuring: ± 2°C
- Range of collector temperature measuring: -10 ~200 °C
- Range of tank temperature measuring: 0 ~100 °C
- Suitable power of pump: 4 pumps possible to be connected, power of each pump ≤ 600W .
- Suitable power of auxiliary heating: power ≤1500W
- Inputs: 6 sensors,
- 2 piece Pt1000 sensor (≤500°C) for collector (silicon cable≤280°C),
- 4 pieces NTC10K, B3950 sensor (≤ 135°C) for tank, (PVC cable ≤105°C),
- Ambient temperature : -10°C ~ 50°C.
- Water proof grade: IP40.

## **9. Delivery scope**

- |   |          |
|---|----------|
| • Controller  | 1 piece  |
| • Customer manual                                     | 1 piece  |
| • Pt1000 sensor ( size: φ6 X 50mm, cable length 1.5m) | 2 pieces |
| • NTC10K sensor( size: φ6 X 50mm,cable length1.5 m)   | 4 pieces |
| • Plastic expansion screw                             | 3 pieces |
| • Screw   | 3 pieces |
| • Strain-relief clamp                                 | 1 bag    |

## 10. Device matchable to this controller

- Sensor for collector: high accuracy PT1000 sensor(A01)  
Parameter: PT1000,  $\phi 6 \times 50 \text{mm}$



- Sensor for tank: high accuracy NTC 10K sensor (A02)  
Parameter: NTC10K,  $B=3950$ ,  $\phi 6 \times 50 \text{mm}$



- Thermowell of sensor: stainless thermowell (A05)  
Parameter: 1/2' male thread,  $\phi 8 \times 200 \text{mm}$ .



- Contactor unit of high power: SR802

When user selects electrical heater as back-up device, we recommend using SR802 unit connecting controller and electrical heater.

Technical data of SR802

Dimension: 100mmx100mmx65mm

Power supply: 180V~264V/AC 50/60Hz

Suitable power:  $\leq 4000 \text{W}$

Available ambient temperature:  $-10 \sim 50^\circ \text{C}$

Water proof grade: IP43

SR802 CONNECTION DIAGRAM:

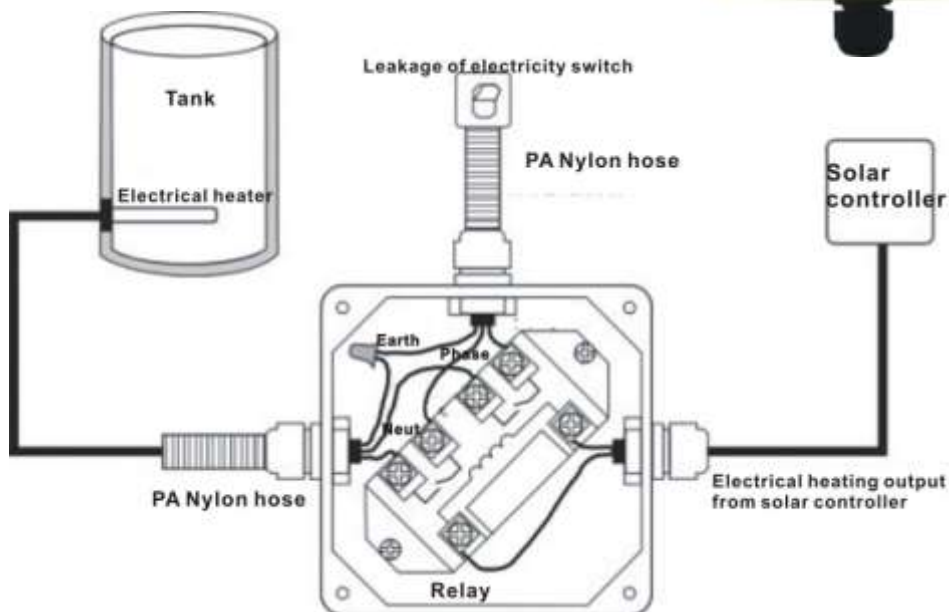

### 11.system survey

